

## X-BLQ3000-E01 Datasheet



- 70 to 3000 mm travel
- Up to 2.0 m/s speed, 55 N thrust, and 20 kg load capacity
- Encoder position feedback with slip/stall detection and automatic recovery
- Built-in controller; daisy-chains with any other Zaber products

### X-BLQ-E Series Overview

Zaber's X-BLQ-E Series products are computer controlled, belt-driven linear stages with integrated stepper motors and controllers. A built-in motor encoder allows closed-loop operation with slip/stall recovery features. They are stand-alone devices requiring only a standard 48 V power supply for operation.

An indexed knob provides convenient manual control for versatile operation even without a computer. These stages connect to the RS-232 port or USB port of any computer, and they can be daisy-chained with any other Zaber products. The daisy-chain also shares power, making it possible for multiple X-Series products to share a single power supply. Convenient locking, 4-pin, M8 connectors on the unit allow for secure connection between devices.

With travel lengths up to 3 m, 20  $\mu$ m repeatability, and a maximum speed of 2.0 m/s, X-BLQ-E stages are perfect for rapid positioning over large distances. Like all of Zaber's products, the X-BLQ-E Series is designed to be 'plug and play' and very easy to set up and operate.

For more information visit: <https://www.zaber.com/products/linear-stages/X-BLQ-E>

## X-BLQ-E Series Part Numbering

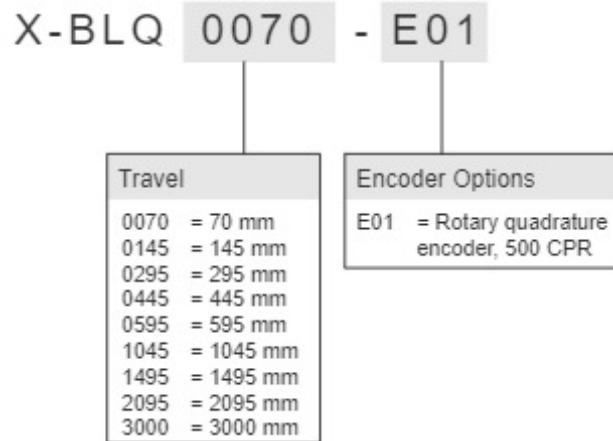

# X-BLQ3000-E01 Drawings

## ZABER

**X-BLQ-E Motorized Linear Stage**  
dimensions in mm

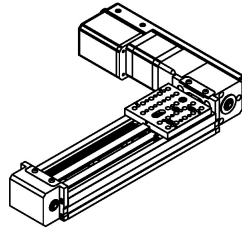

Model Number*	Travel	A	B
X-BLQ0070-E	70.0	235.2	140.5
X-BLQ0145-E	145.0	310.2	215.5
X-BLQ0295-E	295.0	460.2	365.5
X-BLQ0445-E	445.0	610.2	515.5
X-BLQ0595-E	595.0	760.2	665.5
X-BLQ1045-E	1045.0	1212.2	1117.5
X-BLQ1495-E	1495.0	1662.2	1567.5
X-BLQ2095-E	2095.0	2262.2	2167.5
X-BLQ3000-E	3000.0	3168.2	3073.5

\*See product page for complete list of available models at [www.zaber.com](http://www.zaber.com)

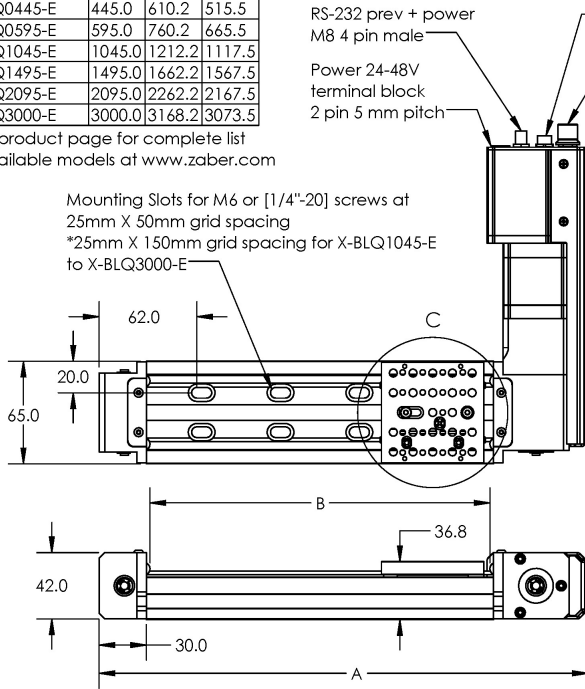

22X M6X1.0  $\nabla$  7.3  
at 12.5mm grid spacing

17X [8-32 UNC]  $\nabla$  7.3  
at [1/2"] grid spacing

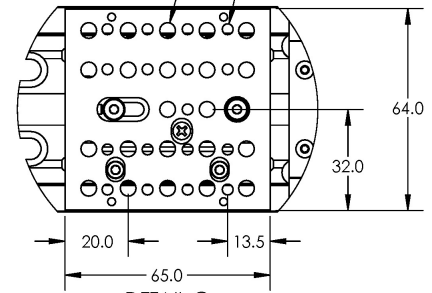

DETAIL C  
SCALE 2 : 3

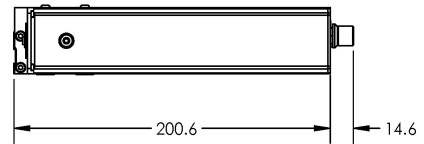

## X-BLQ3000-E01 Specifications

Specification	Value	Alternate Unit
Microstep Size (Default Resolution)	4.21875 $\mu\text{m}$	
Built-in Controller	Yes	
Travel Range	3000 mm	118.110"
Accuracy (unidirectional)	2200 $\mu\text{m}$	0.086614"
Repeatability	< 20 $\mu\text{m}$	< 0.000787"
Backlash	< 75 $\mu\text{m}$	< 0.002953"
Maximum Speed	2000 mm/s	78.740"/s
Minimum Speed	0.002576 mm/s	0.000101"/s
Speed Resolution	0.002576 mm/s	0.000101"/s
Encoder Resolution	500 CPR	2000 states/rev
Encoder Type	Rotary quadrature encoder	
Peak Thrust	55 N	12.3 lb
Maximum Continuous Thrust	20 N	4.5 lb
Communication Interface	RS-232	
Communication Protocol	Zaber ASCII (Default), Zaber Binary	
Data Cable Connection	Locking 4-pin M8	
Maximum Centered Load	200 N	44.9 lb
Maximum Cantilever Load	1500 N-cm	2124.2 oz-in
Guide Type	Recirculating Ball Linear Guide	
Vertical Runout	< 30 $\mu\text{m}$	< 0.001181"
Power Supply	24-48 VDC	
Maximum Current Draw	1800 mA	
Linear Motion Per Motor Rev	54 mm	2.126"
Motor Steps Per Rev	200	
Motor Type	Stepper (2 phase)	
Motor Rated Current	2300 mA/phase	
Inductance	2.2 mH/phase	
Default Resolution	1/64 of a step	
Mechanical Drive System	Synchronous belt	
Limit or Home Sensing	Magnetic home sensor	

Specification	Value	Alternate Unit
Manual Control	Indexed knob with push switch	
Axes of Motion	1	
Mounting Interface	M6 threaded holes and 8-32 threaded holes	
Stage Parallelism	< 100 $\mu\text{m}$	< 0.003937"
Operating Temperature Range	0 to 50 $^{\circ}\text{C}$	
RoHS Compliant	Yes	
CE Compliant	Yes	
Vacuum Compatible	No	
Weight	7.8 kg	17.196 lb

## X-BLQ-E Series Charts

### Thrust Speed Performance

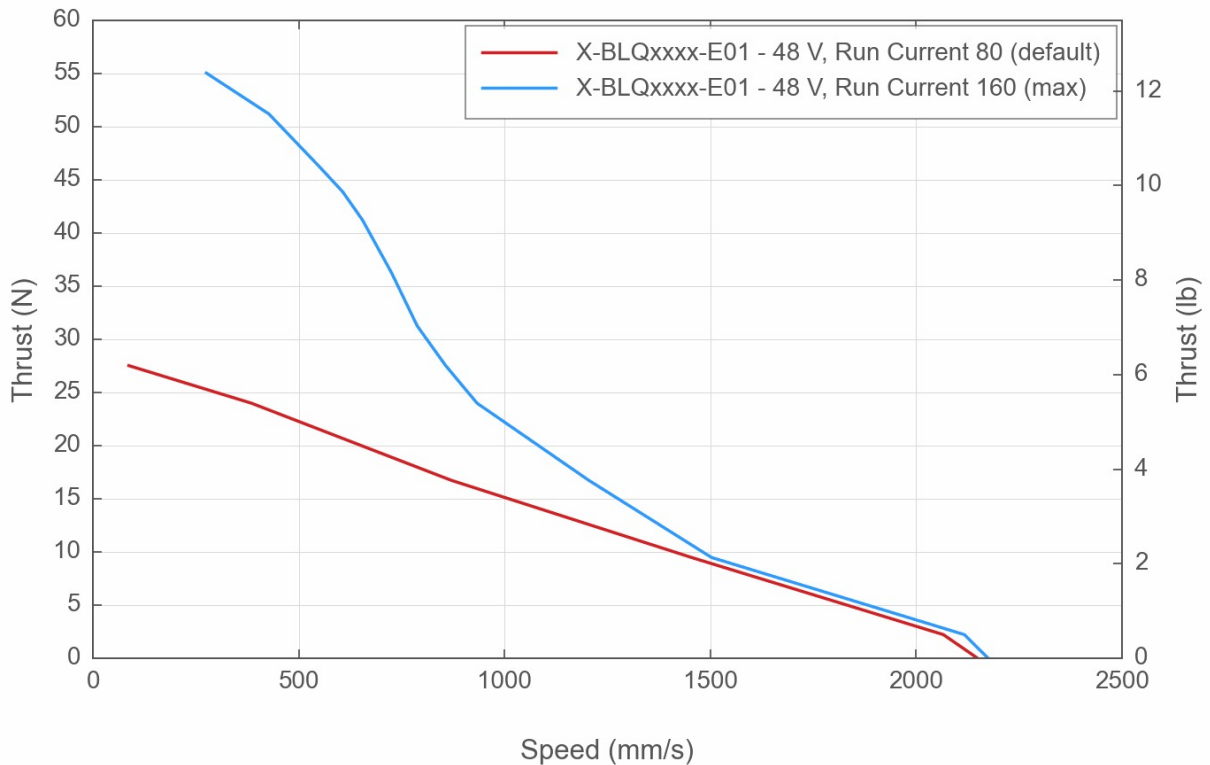

## Horizontal Acceleration

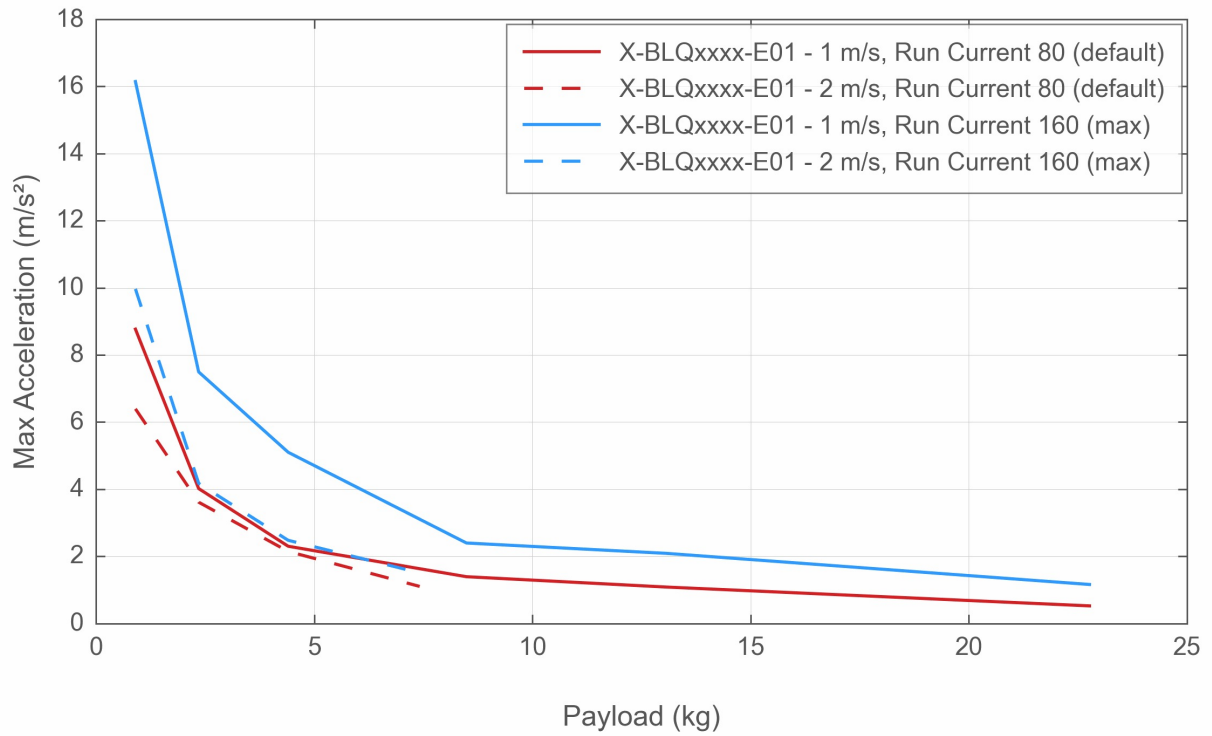

## Typical Accuracy

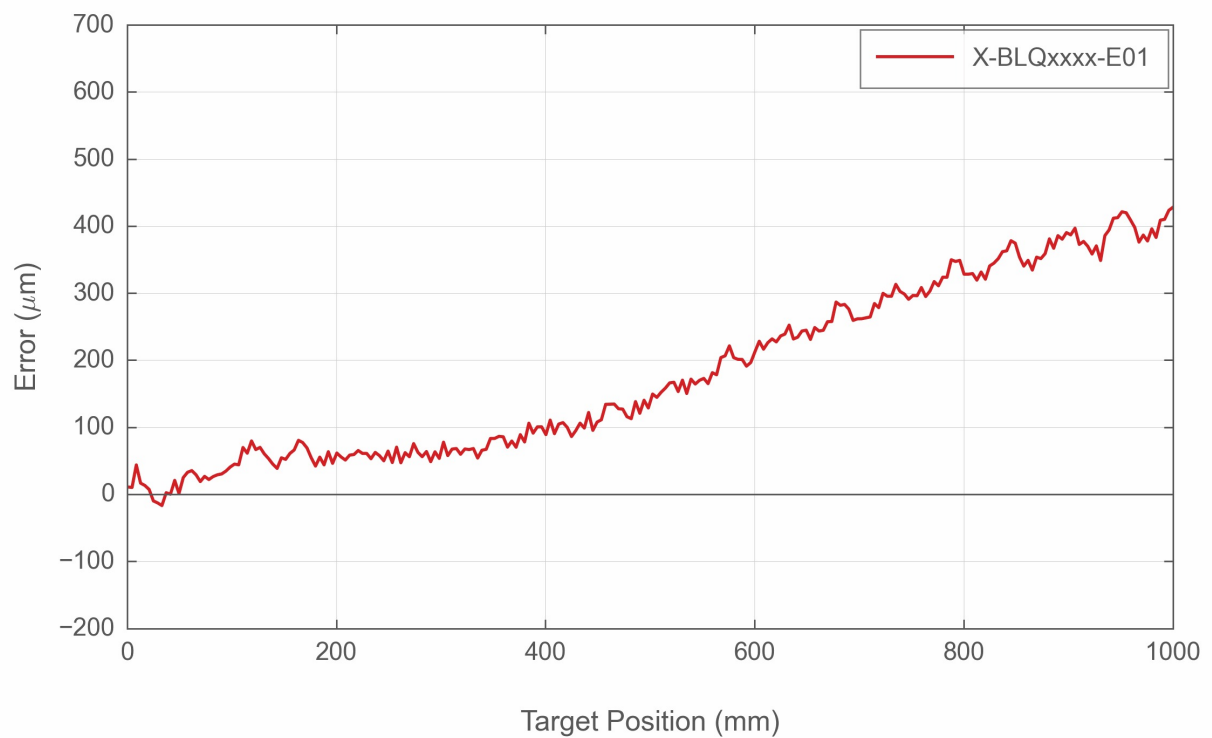

## Contact

Email: [contact@zaber.com](mailto:contact@zaber.com)

Phone (toll free Canada/USA): 1-888-276-8033

Phone (direct): 1-604-569-3780

Fax: 1-604-648-8033

Zaber Technologies Inc.

#2 - 605 West Kent Ave. N.

Vancouver, British Columbia

Canada, V6P 6T7

<https://www.zaber.com>