

X-LRM050A Datasheet



- 25, 50, 100, 150, 200 mm travel options
- Up to 8 μm accuracy and 50 nm resolution
- 50 kg load capacity
- Hardened steel construction and integrated recirculating ball bearing guide provide exceptional stiffness and thermal stability
- Built-in controller, daisy-chains with other Zaber products

X-LRM Series Overview

Zaber's X-LRM Series products are motorized linear stages with integrated controllers. The X-LRM's hardened steel construction and recirculating ball bearing guide provide exceptional rigidity and thermal stability. High stiffness makes the X-LRM ideal for multi-axis configurations or applications where excellent stability under cantilever loads is required.

The X-LRM stages are stand-alone units requiring only a standard 24-48 V power supply. An indexed knob at the end of the unit permits manual control - press and hold to switch between velocity mode and position mode, turn to move the stage, and press to stop.

The stages connect to the USB 2.0 or RS-232 port of any computer and can be chained with several units per chain. They can be chained with any other Zaber products. Convenient locking, 4-pin, M8 connectors on the unit allow for easy and secure connection between products. The chain also shares

power, so multiple X-Series products can use a single power supply.

For more information visit: <https://www.zaber.com/products/linear-stages/X-LRM>

X-LRM Series Part Numbering

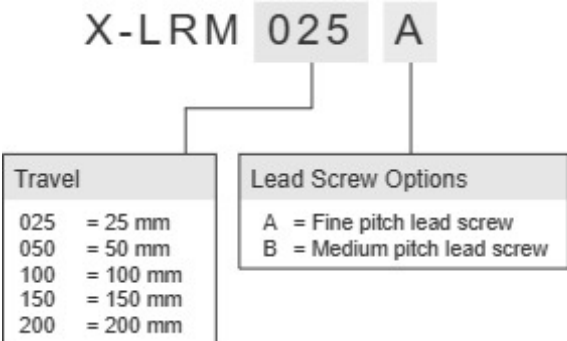

X-LRM050A Drawings

ZABER

X-LRM Motorized Linear Stage
 dimensions in mm

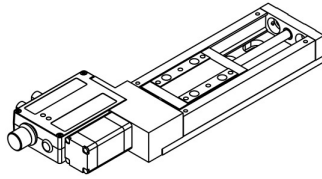

Model Number*	Travel	A	B
X-LRM025	25.0	190.9	93.8
X-LRM050	50.0	215.9	118.8
X-LRM100	100.0	265.9	168.8
X-LRM150	150.0	315.9	218.8
X-LRM200	200.0	365.9	268.8

*See product page for complete list of available models at www.zaber.com

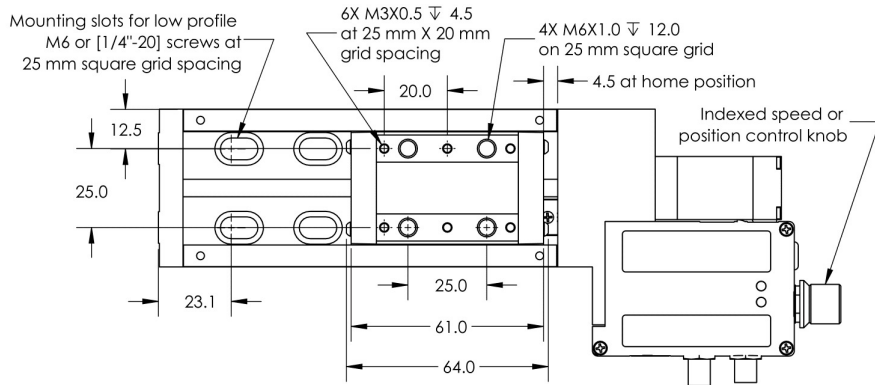

Mounting hole for low profile M6 or [1/4"-20] screws
 Access from inside for vertical mounting

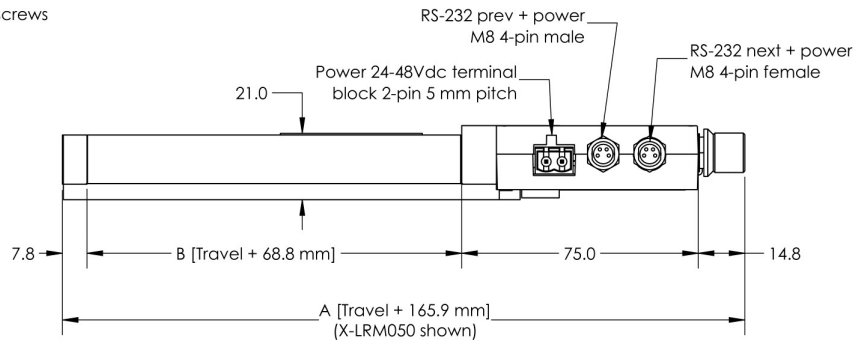
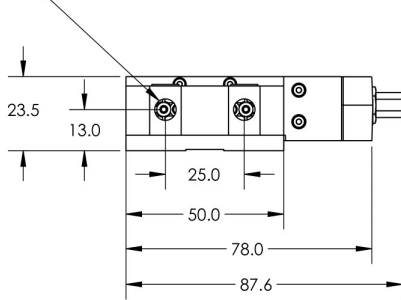

DWG 1082 R02

X-LRM050A Specifications

Specification	Value	Alternate Unit
Microstep Size (Default Resolution)	0.047625 μm	
Built-in Controller	Yes	
Travel Range	50.0 mm	1.969"
Accuracy (unidirectional)	15 μm	0.000591"
Repeatability	< 4 μm	< 0.000157"
Backlash	< 5 μm	< 0.000197"
Maximum Speed	25 mm/s	0.984"/s
Minimum Speed	0.000029 mm/s	0.000001"/s
Speed Resolution	0.000029 mm/s	0.000001"/s
Encoder Type	None	
Peak Thrust	50 N	11.2 lb
Maximum Continuous Thrust	25 N	5.6 lb
Communication Interface	RS-232, USB 2.0	
Communication Protocol	Zaber ASCII (Default), Zaber Binary	
Data Cable Connection	Locking 4-pin M8	
Maximum Centered Load	500 N	112.1 lb
Maximum Cantilever Load	1500 N-cm	2124.2 oz-in
Guide Type	Recirculating ball bearing	
Vertical Runout	< 8 μm	< 0.000315"
Horizontal Runout	< 12 μm	< 0.000472"
Pitch	0.02°	0.349 mrad
Roll	0.02°	0.349 mrad
Yaw	0.02°	0.349 mrad
Stiffness in Pitch	750 N-m/°	23 $\mu\text{rad/N-m}$
Stiffness in Roll	550 N-m/°	32 $\mu\text{rad/N-m}$
Stiffness in Yaw	400 N-m/°	44 $\mu\text{rad/N-m}$
Power Supply	24-48 VDC	
Power Plug	2-pin Screw Terminal	
Maximum Current Draw	350 mA	
Linear Motion Per Motor Rev	0.6096 mm	0.024"

Specification	Value	Alternate Unit
Motor Steps Per Rev	200	
Motor Type	Stepper (2 phase)	
Motor Rated Current	600 mA/phase	
Inductance	3.5 mH/phase	
Default Resolution	1/64 of a step	
Mechanical Drive System	Precision lead screw	
Limit or Home Sensing	Magnetic hall sensor	
Manual Control	Yes	
Axes of Motion	1	
Mounting Interface	M3 and M6 threaded holes	
Stage Parallelism	< 10 μ m	< 0.000394"
Operating Temperature Range	0 to 50 °C	
RoHS Compliant	Yes	
CE Compliant	Yes	
Vacuum Compatible	No	
Weight	0.80 kg	1.764 lb

X-LRM Series Charts

Thrust Speed Performance

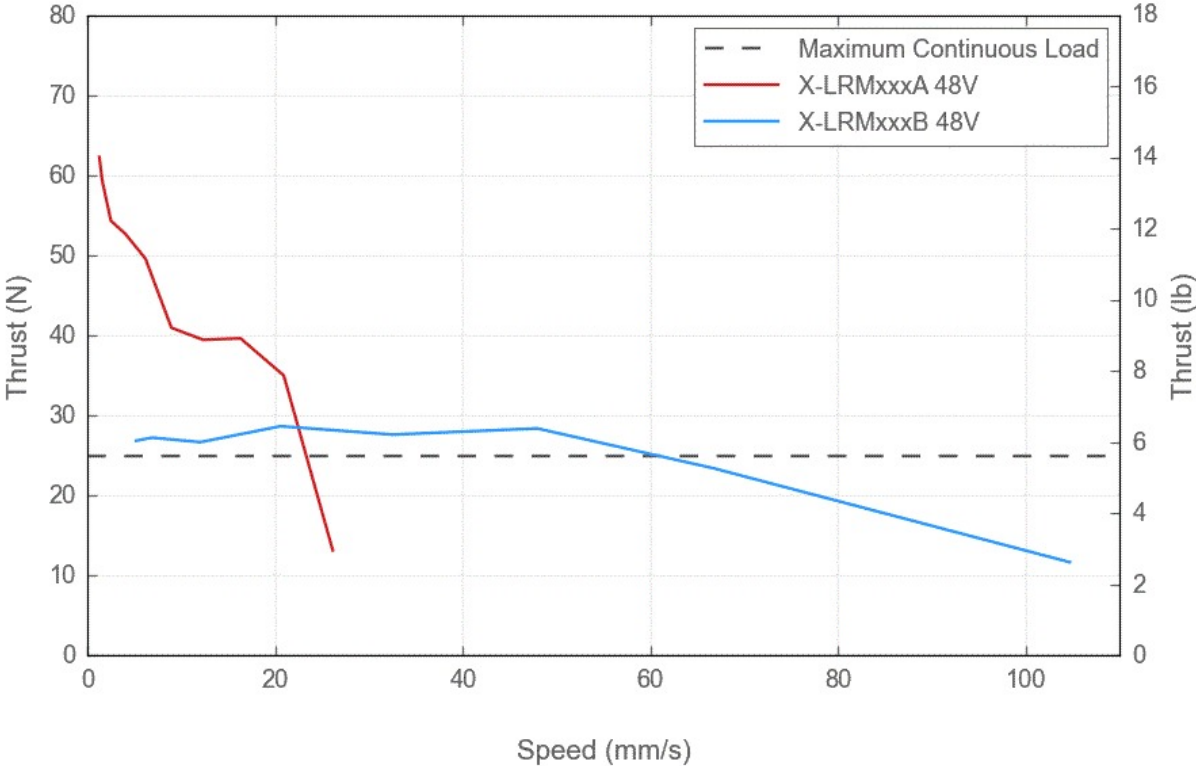

Thrust Speed Performance

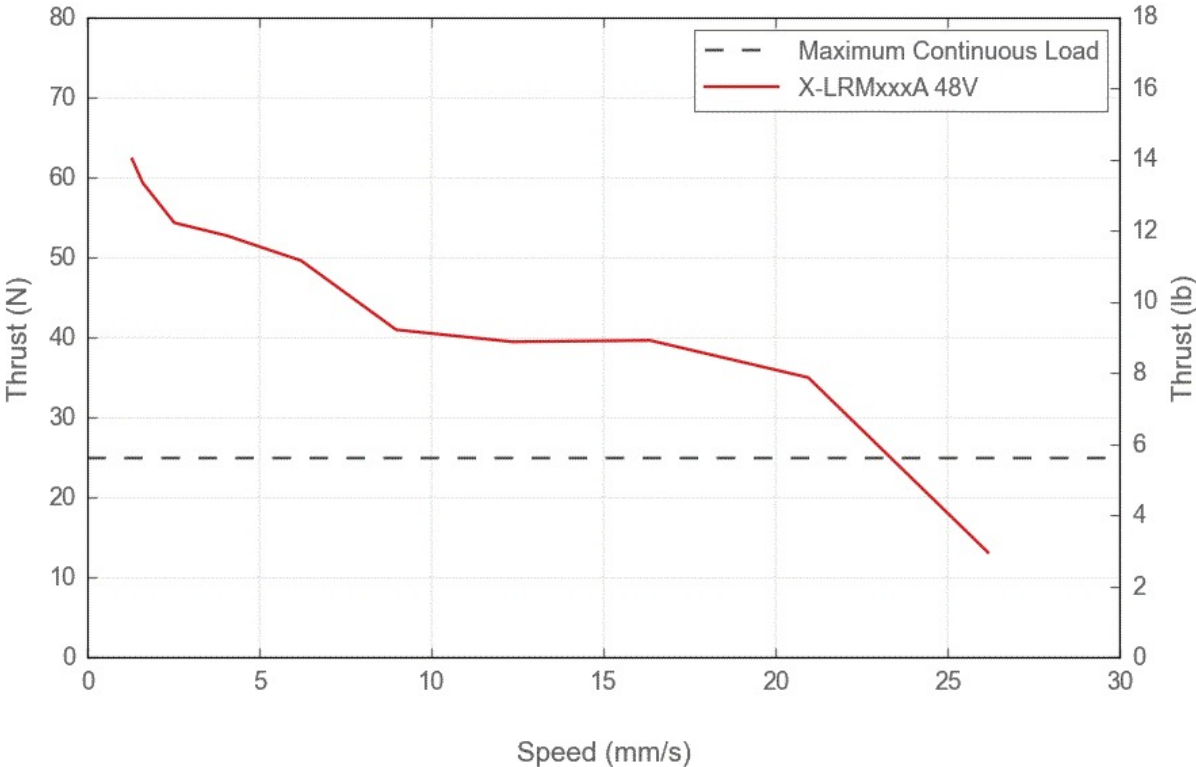

Thrust Speed Performance

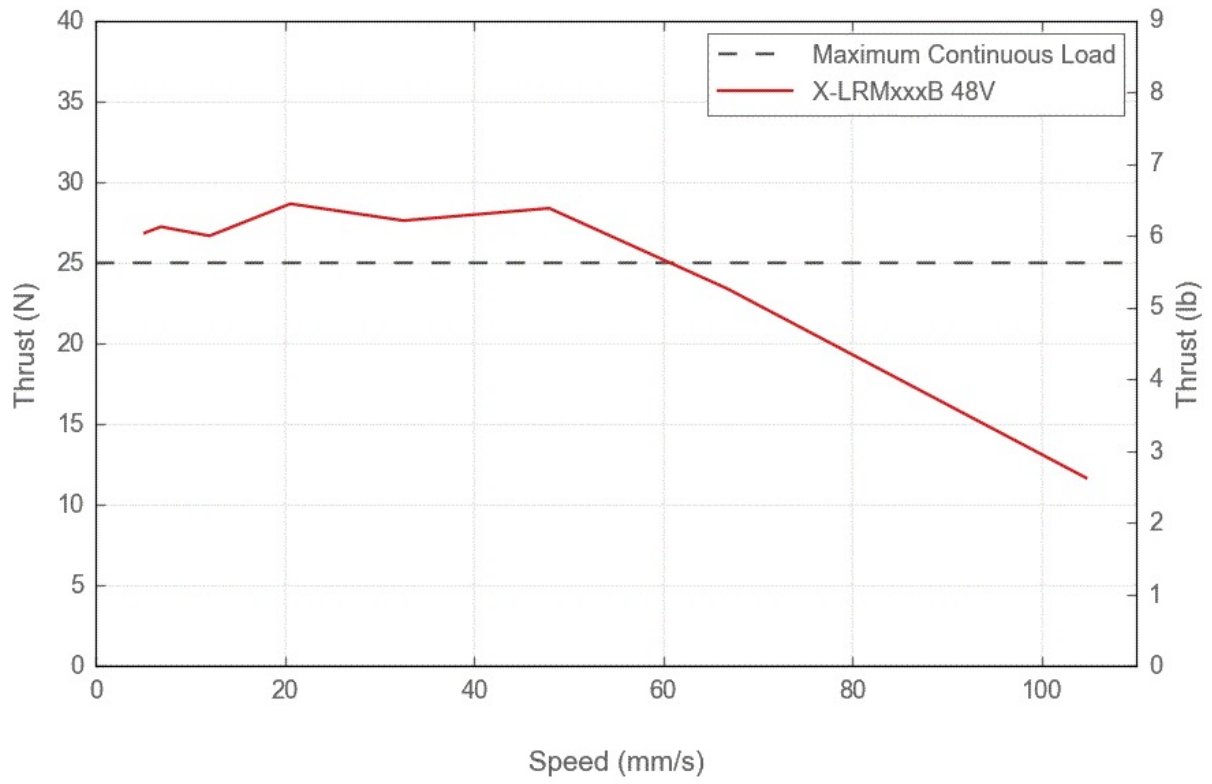

Typical Microstepping Accuracy

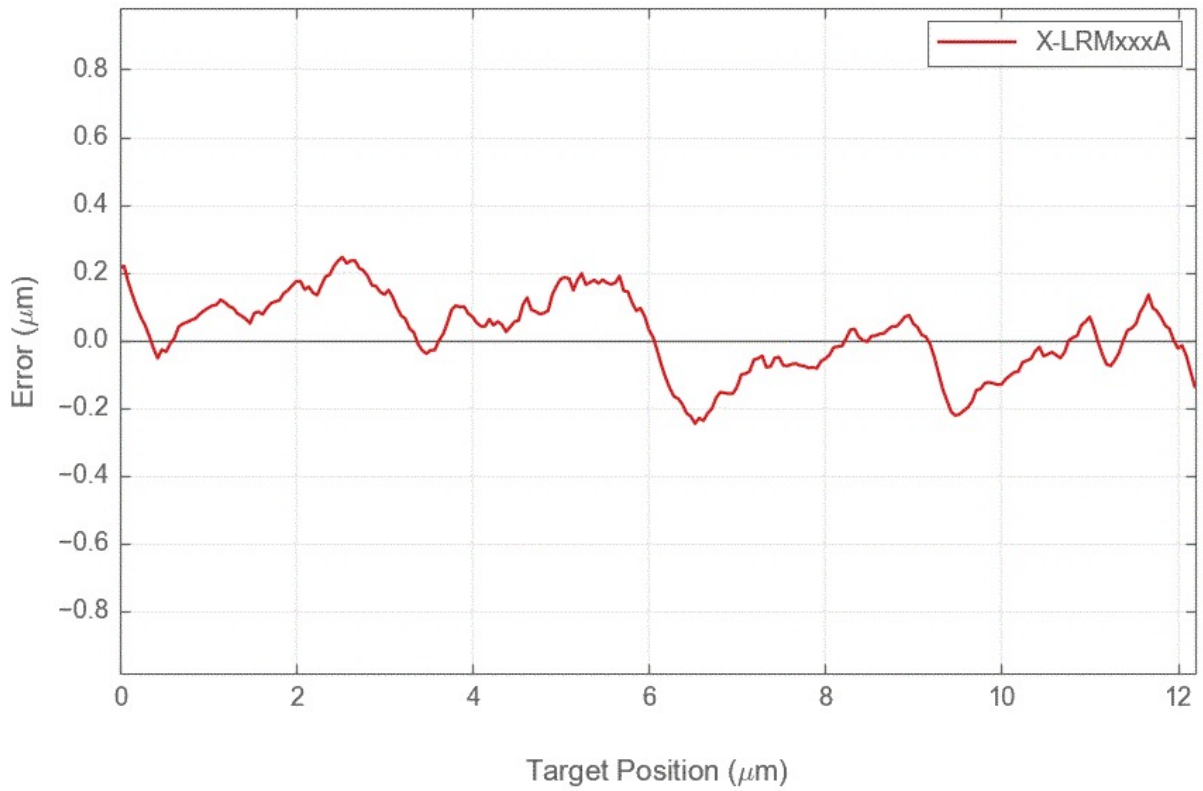

Typical Microstepping Accuracy

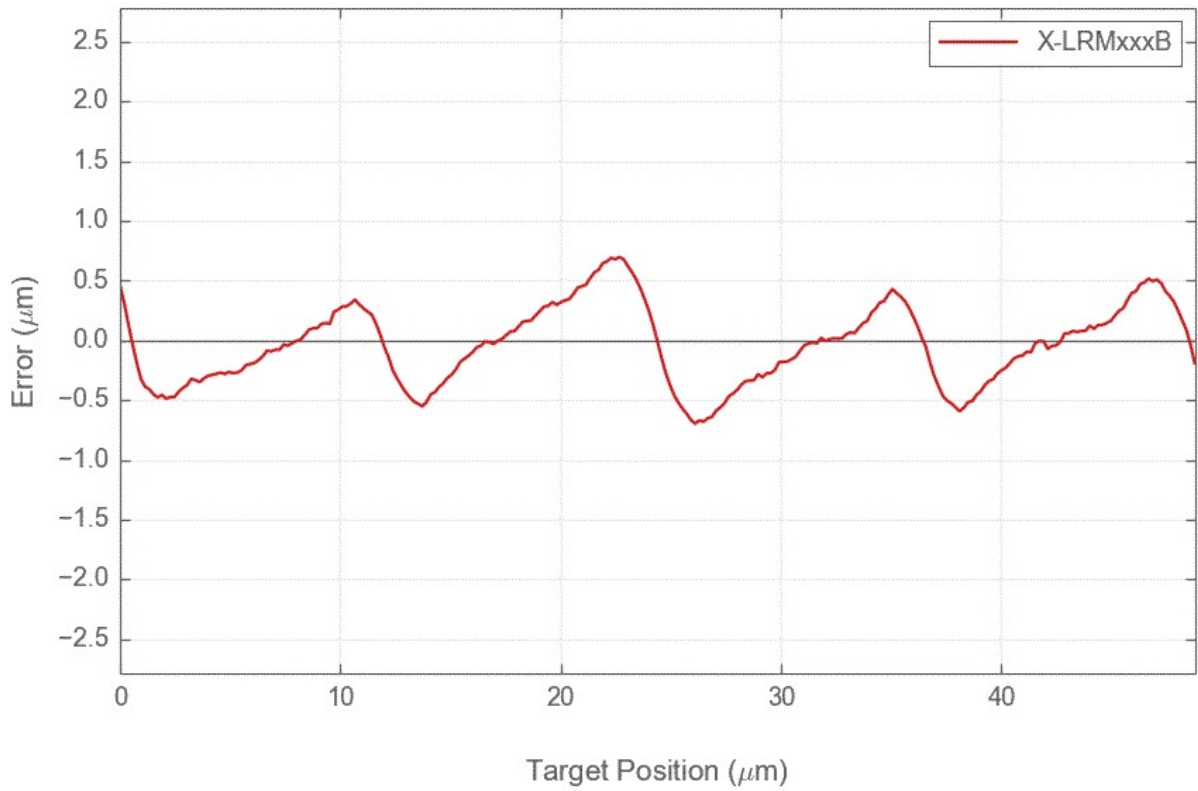

LRM Linear Bearing Lifetime

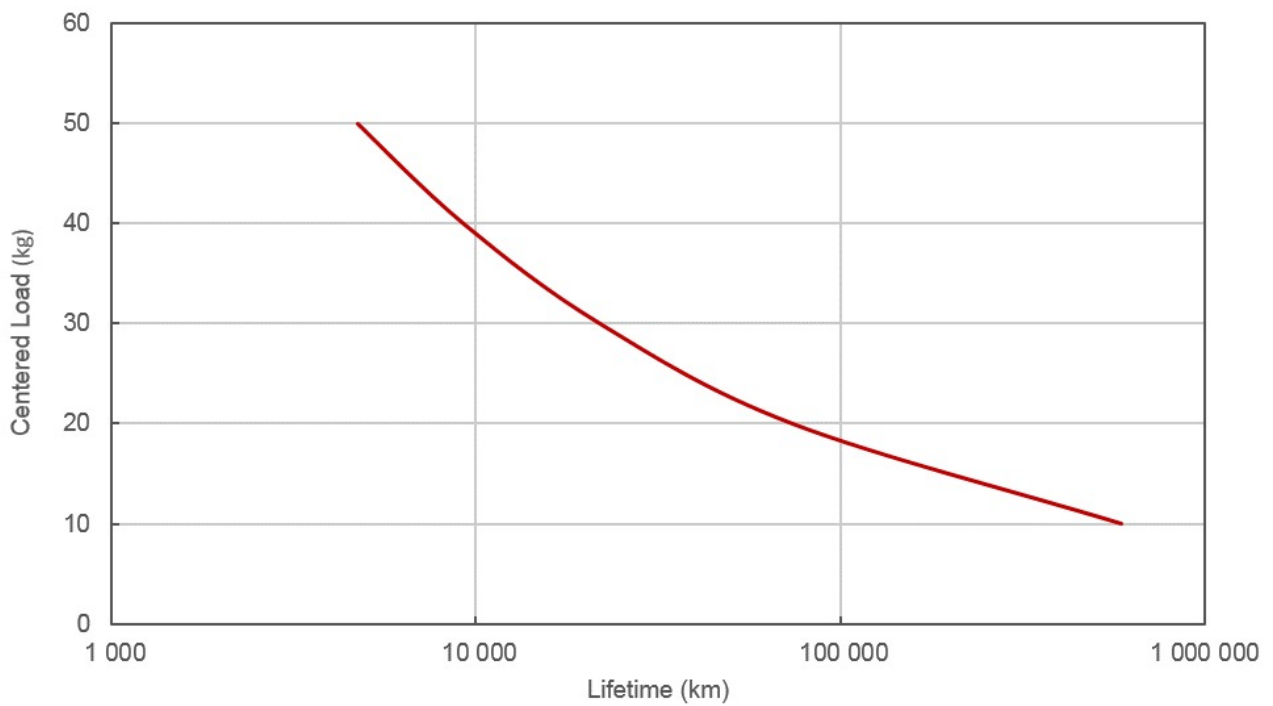

Contact

Email: contact@zaber.com

Phone (toll free Canada/USA): 1-888-276-8033

Phone (direct): 1-604-569-3780

Fax: 1-604-648-8033

Zaber Technologies Inc.

#2 - 605 West Kent Ave. N.

Vancouver, British Columbia

Canada, V6P 6T7

<https://www.zaber.com>