

LRQ-E Series Datasheet



- 75, 150, 300, 450, 600 mm travel
- Up to 840 mm/s speed and up to 500 N thrust
- 100 kg load capacity
- Inline and parallel drive configurations
- Encoder position feedback with slip/stall detection and automatic recovery
- Ball screw and lead screw configurations
- Designed for use with an X-MCC Series stepper motor controller or any 2-phase stepper motor controller
- With AutoDetect, the X-MCC controller configures its settings automatically for the connected peripheral
- Custom versions available

LRQ-E Series Overview

Zaber's LRQ-E Series products are computer-controlled, motorized linear stages with high stiffness, load, and lifetime capabilities in a compact size. At only 36 mm high, these stages are excellent for applications where a low profile is required. These stages are capable of speeds up to 840 mm/s, and can bolt together into XY and XYZ systems. Some multi axis configurations may require additional accessories, please contact Zaber Technical Support to ensure the correct ones are selected. Each device is available in either an inline or parallel drive configuration. The built-in motor encoder allows for closed-loop operation and slip/stall recovery features.

The stages are designed to connect directly to our X-MCC Series universal motor controllers, or they can be used with any 2-phase stepper motor controller through the panel mount DB15 connector. Set up is easy with AutoDetect. Once connected, the X-MCC controller will automatically detect and configure the LRQ-E.

For more information visit: <https://www.zaber.com/products/linear-stages/LRQ-E>

LRQ-E Series Part Numbering & Options

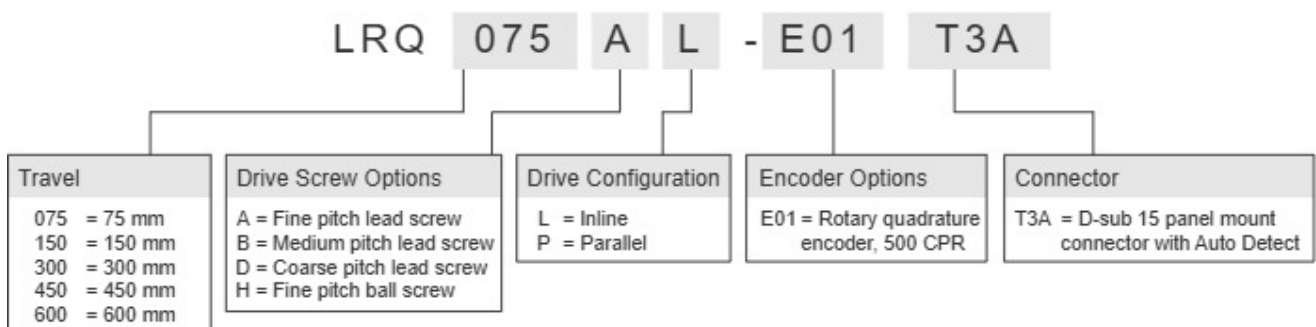

LRQ-E Series Drawings

- [LRQxL-E.png \(Dimension Drawing for the LRQxL-E\)](#)
- [LRQxP-E.png \(Dimension Drawing for the LRQxP-E\)](#)

LRQ-E Series Specifications

Built-in Controller	
Recommended Controller	X-MCC (48 V) Recommended
AutoDetect	Yes
Encoder Resolution	500 CPR (2000 states/rev)
Encoder Type	Rotary quadrature encoder
Maximum Centered Load	1000 N (224.3 lb)
Maximum Moment (Pitch)	30 N-m (22.1 ft-lb)
Maximum Moment (Roll)	30 N-m (22.1 ft-lb)
Maximum Moment (Yaw)	30 N-m (22.1 ft-lb)
Stiffness in Pitch	500 N-m/° (35 µrad/N-m)
Stiffness in Roll	1180 N-m/° (15 µrad/N-m)
Stiffness in Yaw	450 N-m/° (39 µrad/N-m)
Motor Steps Per Rev	200
Motor Type	Stepper (2 phase)
Motor Rated Current	2300 mA/phase
Motor Winding Resistance	1 ohms/phase
Inductance	2.2 mH/phase
Motor Connection	D-sub 15
Default Resolution	1/64 of a step
Guide Type	Recirculating Ball Linear Guide
Limit or Home Sensing	Magnetic home sensor
Axes of Motion	1
Mounting Interface	M6 and M3 threaded holes
Operating Temperature Range	0 to 50 °C
CE Compliant	Yes
Vacuum Compatible	No

Part Number	Microstep Size (Default Resolution)	Travel Range	Accuracy (unidirectional)	Repeatability
LRQ075AL-E01T3A	0.09921875 µm	75 mm (2.953")	23 µm (0.000906")	< 2.5 µm (< 0.000098")

Part Number	Microstep Size (Default Resolution)	Travel Range	Accuracy (unidirectional)	Repeatability
LRQ075BL-E01T3A	0.49609375 µm	75 mm (2.953")	15 µm (0.000591")	< 2.5 µm (< 0.000098")
LRQ075DL-E01T3A	1.984375 µm	75 mm (2.953")	48 µm (0.001890")	< 3 µm (< 0.000118")
LRQ075HL-E01T3A	0.1953125 µm	75 mm (2.953")	17.5 µm (0.000689")	< 5 µm (< 0.000197")
LRQ150AL-E01T3A	0.09921875 µm	150 mm (5.905")	45 µm (0.001772")	< 2.5 µm (< 0.000098")
LRQ150BL-E01T3A	0.49609375 µm	150 mm (5.905")	25 µm (0.000984")	< 2.5 µm (< 0.000098")
LRQ150DL-E01T3A	1.984375 µm	150 mm (5.905")	55 µm (0.002165")	< 3 µm (< 0.000118")
LRQ150HL-E01T3A	0.1953125 µm	150 mm (5.905")	30 µm (0.001181")	< 5 µm (< 0.000197")
LRQ300AL-E01T3A	0.09921875 µm	300 mm (11.811")	90 µm (0.003543")	< 2.5 µm (< 0.000098")
LRQ300BL-E01T3A	0.49609375 µm	300 mm (11.811")	35 µm (0.001378")	< 2.5 µm (< 0.000098")
LRQ300DL-E01T3A	1.984375 µm	300 mm (11.811")	70 µm (0.002756")	< 3 µm (< 0.000118")
LRQ300HL-E01T3A	0.1953125 µm	300 mm (11.811")	55 µm (0.002165")	< 5 µm (< 0.000197")
LRQ450AL-E01T3A	0.09921875 µm	450 mm (17.716")	135 µm (0.005315")	< 2.5 µm (< 0.000098")
LRQ450BL-E01T3A	0.49609375 µm	450 mm (17.716")	60 µm (0.002362")	< 2.5 µm (< 0.000098")
LRQ450DL-E01T3A	1.984375 µm	450 mm (17.716")	85 µm (0.003346")	< 3 µm (< 0.000118")
LRQ450HL-E01T3A	0.1953125 µm	450 mm (17.716")	85 µm (0.003346")	< 5 µm (< 0.000197")
LRQ600AL-E01T3A	0.09921875 µm	600 mm (23.622")	150 µm (0.005905")	< 2.5 µm (< 0.000098")
LRQ600BL-E01T3A	0.49609375 µm	600 mm (23.622")	90 µm (0.003543")	< 2.5 µm (< 0.000098")
LRQ600DL-E01T3A	1.984375 µm	600 mm (23.622")	100 µm (0.003937")	< 3 µm (< 0.000118")
LRQ600HL-E01T3A	0.1953125 µm	600 mm (23.622")	115 µm (0.004528")	< 5 µm (< 0.000197")
LRQ075AP-E01T3A	0.09921875 µm	75 mm (2.953")	23 µm (0.000906")	< 2.5 µm (< 0.000098")
LRQ075BP-E01T3A	0.49609375 µm	75 mm (2.953")	15 µm (0.000591")	< 2.5 µm (< 0.000098")
			15 µm	< 2.5 µm

Part Number	Microstep Size (Default Resolution)	Travel Range	Accuracy (unidirectional)	Repeatability
LRQ075DP-E01T3A	1.984375 µm	75 mm (2.953")	(0.000591")	(< 0.000098")
LRQ075HP-E01T3A	0.1953125 µm	75 mm (2.953")	27.5 µm (0.001083")	< 5 µm (< 0.000197")
LRQ150AP-E01T3A	0.09921875 µm	150 mm (5.905")	45 µm (0.001772")	< 2.5 µm (< 0.000098")
LRQ150BP-E01T3A	0.49609375 µm	150 mm (5.905")	25 µm (0.000984")	< 2.5 µm (< 0.000098")
LRQ150DP-E01T3A	1.984375 µm	150 mm (5.905")	55 µm (0.002165")	< 3 µm (< 0.000118")
LRQ150HP-E01T3A	0.1953125 µm	150 mm (5.905")	40 µm (0.001575")	< 5 µm (< 0.000197")
LRQ300AP-E01T3A	0.09921875 µm	300 mm (11.811")	90 µm (0.003543")	< 2.5 µm (< 0.000098")
LRQ300BP-E01T3A	0.49609375 µm	300 mm (11.811")	35 µm (0.001378")	< 2.5 µm (< 0.000098")
LRQ300DP-E01T3A	1.984375 µm	300 mm (11.811")	70 µm (0.002756")	< 3 µm (< 0.000118")
LRQ300HP-E01T3A	0.1953125 µm	300 mm (11.811")	65 µm (0.002559")	< 5 µm (< 0.000197")
LRQ450AP-E01T3A	0.09921875 µm	450 mm (17.716")	135 µm (0.005315")	< 2.5 µm (< 0.000098")
LRQ450BP-E01T3A	0.49609375 µm	450 mm (17.716")	60 µm (0.002362")	< 2.5 µm (< 0.000098")
LRQ450DP-E01T3A	1.984375 µm	450 mm (17.716")	85 µm (0.003346")	< 3 µm (< 0.000118")
LRQ450HP-E01T3A	0.1953125 µm	450 mm (17.716")	95 µm (0.003740")	< 5 µm (< 0.000197")
LRQ600AP-E01T3A	0.09921875 µm	600 mm (23.622")	150 µm (0.005905")	< 2.5 µm (< 0.000098")
LRQ600BP-E01T3A	0.49609375 µm	600 mm (23.622")	90 µm (0.003543")	< 2.5 µm (< 0.000098")
LRQ600DP-E01T3A	1.984375 µm	600 mm (23.622")	100 µm (0.003937")	< 3 µm (< 0.000118")
LRQ600HP-E01T3A	0.1953125 µm	600 mm (23.622")	125 µm (0.004921")	< 5 µm (< 0.000197")

Part Number	Backlash	Maximum Speed	Minimum Speed	Speed Resolution
LRQ075AL-E01T3A	< 8 µm (< 0.000315")	54 mm/s (2.126"/s)	0.000061 mm/s (0.000002"/s)	0.000061 mm/s (0.000002"/s)

Part Number	Backlash	Maximum Speed	Minimum Speed	Speed Resolution
LRQ075BL-E01T3A	< 21 μm (< 0.000827")	270 mm/s (10.630"/s)	0.000303 mm/s (0.000012"/s)	0.000303 mm/s (0.000012"/s)
LRQ075DL-E01T3A	< 60 μm (< 0.002362")	840 mm/s (33.071"/s)	0.001211 mm/s (0.000048"/s)	0.001211 mm/s (0.000048"/s)
LRQ075HL-E01T3A	< 30 μm (< 0.001181")	110 mm/s (4.331"/s)	0.000119 mm/s (0.000005"/s)	0.000119 mm/s (0.000005"/s)
LRQ150AL-E01T3A	< 8 μm (< 0.000315")	54 mm/s (2.126"/s)	0.000061 mm/s (0.000002"/s)	0.000061 mm/s (0.000002"/s)
LRQ150BL-E01T3A	< 21 μm (< 0.000827")	270 mm/s (10.630"/s)	0.000303 mm/s (0.000012"/s)	0.000303 mm/s (0.000012"/s)
LRQ150DL-E01T3A	< 60 μm (< 0.002362")	840 mm/s (33.071"/s)	0.001211 mm/s (0.000048"/s)	0.001211 mm/s (0.000048"/s)
LRQ150HL-E01T3A	< 30 μm (< 0.001181")	110 mm/s (4.331"/s)	0.000119 mm/s (0.000005"/s)	0.000119 mm/s (0.000005"/s)
LRQ300AL-E01T3A	< 8 μm (< 0.000315")	54 mm/s (2.126"/s)	0.000061 mm/s (0.000002"/s)	0.000061 mm/s (0.000002"/s)
LRQ300BL-E01T3A	< 21 μm (< 0.000827")	270 mm/s (10.630"/s)	0.000303 mm/s (0.000012"/s)	0.000303 mm/s (0.000012"/s)
LRQ300DL-E01T3A	< 60 μm (< 0.002362")	840 mm/s (33.071"/s)	0.001211 mm/s (0.000048"/s)	0.001211 mm/s (0.000048"/s)
LRQ300HL-E01T3A	< 30 μm (< 0.001181")	110 mm/s (4.331"/s)	0.000119 mm/s (0.000005"/s)	0.000119 mm/s (0.000005"/s)
LRQ450AL-E01T3A	< 8 μm (< 0.000315")	54 mm/s (2.126"/s)	0.000061 mm/s (0.000002"/s)	0.000061 mm/s (0.000002"/s)
LRQ450BL-E01T3A	< 21 μm (< 0.000827")	270 mm/s (10.630"/s)	0.000303 mm/s (0.000012"/s)	0.000303 mm/s (0.000012"/s)
LRQ450DL-E01T3A	< 60 μm (< 0.002362")	840 mm/s (33.071"/s)	0.001211 mm/s (0.000048"/s)	0.001211 mm/s (0.000048"/s)
LRQ450HL-E01T3A	< 30 μm (< 0.001181")	110 mm/s (4.331"/s)	0.000119 mm/s (0.000005"/s)	0.000119 mm/s (0.000005"/s)
LRQ600AL-E01T3A	< 8 μm (< 0.000315")	54 mm/s (2.126"/s)	0.000061 mm/s (0.000002"/s)	0.000061 mm/s (0.000002"/s)
LRQ600BL-E01T3A	< 21 μm (< 0.000827")	270 mm/s (10.630"/s)	0.000303 mm/s (0.000012"/s)	0.000303 mm/s (0.000012"/s)
LRQ600DL-E01T3A	< 60 μm (< 0.002362")	840 mm/s (33.071"/s)	0.001211 mm/s (0.000048"/s)	0.001211 mm/s (0.000048"/s)
LRQ600HL-E01T3A	< 30 μm (< 0.001181")	110 mm/s (4.331"/s)	0.000119 mm/s (0.000005"/s)	0.000119 mm/s (0.000005"/s)
LRQ075AP-E01T3A	< 14 μm (< 0.000551")	54 mm/s (2.126"/s)	0.000061 mm/s (0.000002"/s)	0.000061 mm/s (0.000002"/s)
LRQ075BP-E01T3A	< 27 μm (< 0.001063")	270 mm/s (10.630"/s)	0.000303 mm/s (0.000012"/s)	0.000303 mm/s (0.000012"/s)

Part Number	Backlash	Maximum Speed	Minimum Speed	Speed Resolution
LRQ075DP-E01T3A	< 130 μm (< 0.005118")	840 mm/s (33.071"/s)	0.000303 mm/s (0.000012"/s)	0.000303 mm/s (0.000012"/s)
LRQ075HP-E01T3A	< 30 μm (< 0.001181")	110 mm/s (4.331"/s)	0.000119 mm/s (0.000005"/s)	0.000119 mm/s (0.000005"/s)
LRQ150AP-E01T3A	< 14 μm (< 0.000551")	54 mm/s (2.126"/s)	0.000061 mm/s (0.000002"/s)	0.000061 mm/s (0.000002"/s)
LRQ150BP-E01T3A	< 27 μm (< 0.001063")	270 mm/s (10.630"/s)	0.000303 mm/s (0.000012"/s)	0.000303 mm/s (0.000012"/s)
LRQ150DP-E01T3A	< 130 μm (< 0.005118")	840 mm/s (33.071"/s)	0.001211 mm/s (0.000048"/s)	0.001211 mm/s (0.000048"/s)
LRQ150HP-E01T3A	< 30 μm (< 0.001181")	110 mm/s (4.331"/s)	0.000119 mm/s (0.000005"/s)	0.000119 mm/s (0.000005"/s)
LRQ300AP-E01T3A	< 14 μm (< 0.000551")	54 mm/s (2.126"/s)	0.000061 mm/s (0.000002"/s)	0.000061 mm/s (0.000002"/s)
LRQ300BP-E01T3A	< 27 μm (< 0.001063")	270 mm/s (10.630"/s)	0.000303 mm/s (0.000012"/s)	0.000303 mm/s (0.000012"/s)
LRQ300DP-E01T3A	< 130 μm (< 0.005118")	840 mm/s (33.071"/s)	0.001211 mm/s (0.000048"/s)	0.001211 mm/s (0.000048"/s)
LRQ300HP-E01T3A	< 30 μm (< 0.001181")	110 mm/s (4.331"/s)	0.000119 mm/s (0.000005"/s)	0.000119 mm/s (0.000005"/s)
LRQ450AP-E01T3A	< 14 μm (< 0.000551")	54 mm/s (2.126"/s)	0.000061 mm/s (0.000002"/s)	0.000061 mm/s (0.000002"/s)
LRQ450BP-E01T3A	< 27 μm (< 0.001063")	270 mm/s (10.630"/s)	0.000303 mm/s (0.000012"/s)	0.000303 mm/s (0.000012"/s)
LRQ450DP-E01T3A	< 130 μm (< 0.005118")	840 mm/s (33.071"/s)	0.001211 mm/s (0.000048"/s)	0.001211 mm/s (0.000048"/s)
LRQ450HP-E01T3A	< 30 μm (< 0.001181")	110 mm/s (4.331"/s)	0.000119 mm/s (0.000005"/s)	0.000119 mm/s (0.000005"/s)
LRQ600AP-E01T3A	< 14 μm (< 0.000551")	54 mm/s (2.126"/s)	0.000061 mm/s (0.000002"/s)	0.000061 mm/s (0.000002"/s)
LRQ600BP-E01T3A	< 27 μm (< 0.001063")	270 mm/s (10.630"/s)	0.000303 mm/s (0.000012"/s)	0.000303 mm/s (0.000012"/s)
LRQ600DP-E01T3A	< 130 μm (< 0.005118")	840 mm/s (33.071"/s)	0.001211 mm/s (0.000048"/s)	0.001211 mm/s (0.000048"/s)
LRQ600HP-E01T3A	< 30 μm (< 0.001181")	110 mm/s (4.331"/s)	0.000119 mm/s (0.000005"/s)	0.000119 mm/s (0.000005"/s)

Part Number	Peak Thrust	Back-driving Force*	Maximum Continuous Thrust	Vertical Runout
LRQ075AL-E01T3A	230 N (51.6 lb)	Non-back-driving (\pm 30%) 93 N	100 N (22.4 lb)	< 20 μm (< 0.000787") < 20 μm

Part Number	Peak Thrust	Back-driving Force*	Maximum Continuous Thrust	Vertical Runout
LRQ075BL-E01T3A	150 N (33.6 lb)	(20.9 lb)	100 N (22.4 lb)	(< 0.000787")
LRQ075DL-E01T3A	35 N (7.8 lb)	(± 30%) 14 N (3.1 lb)	35 N (7.8 lb)	< 20 µm (< 0.000787")
LRQ075HL-E01T3A	500 N (112.1 lb)	(± 30%) 93 N (20.9 lb)	200 N (44.9 lb)	< 20 µm (< 0.000787")
LRQ150AL-E01T3A	230 N (51.6 lb)	Non-back-driving	100 N (22.4 lb)	< 25 µm (< 0.000984")
LRQ150BL-E01T3A	150 N (33.6 lb)	(± 30%) 93 N (20.9 lb)	100 N (22.4 lb)	< 25 µm (< 0.000984")
LRQ150DL-E01T3A	35 N (7.8 lb)	(± 30%) 14 N (3.1 lb)	35 N (7.8 lb)	< 25 µm (< 0.000984")
LRQ150HL-E01T3A	500 N (112.1 lb)	(± 30%) 93 N (20.9 lb)	200 N (44.9 lb)	< 25 µm (< 0.000984")
LRQ300AL-E01T3A	230 N (51.6 lb)	Non-back-driving	100 N (22.4 lb)	< 35 µm (< 0.001378")
LRQ300BL-E01T3A	150 N (33.6 lb)	(± 30%) 93 N (20.9 lb)	100 N (22.4 lb)	< 35 µm (< 0.001378")
LRQ300DL-E01T3A	35 N (7.8 lb)	(± 30%) 14 N (3.1 lb)	35 N (7.8 lb)	< 35 µm (< 0.001378")
LRQ300HL-E01T3A	500 N (112.1 lb)	(± 30%) 93 N (20.9 lb)	200 N (44.9 lb)	< 35 µm (< 0.001378")
LRQ450AL-E01T3A	230 N (51.6 lb)	Non-back-driving	100 N (22.4 lb)	< 45 µm (< 0.001772")
LRQ450BL-E01T3A	150 N (33.6 lb)	(± 30%) 93 N (20.9 lb)	100 N (22.4 lb)	< 45 µm (< 0.001772")
LRQ450DL-E01T3A	35 N (7.8 lb)	(± 30%) 14 N (3.1 lb)	35 N (7.8 lb)	< 45 µm (< 0.001772")
LRQ450HL-E01T3A	500 N (112.1 lb)	(± 30%) 93 N (20.9 lb)	200 N (44.9 lb)	< 45 µm (< 0.001772")
LRQ600AL-E01T3A	230 N (51.6 lb)	Non-back-driving	100 N (22.4 lb)	< 75 µm (< 0.002953")
LRQ600BL-E01T3A	150 N (33.6 lb)	(± 30%) 93 N (20.9 lb)	100 N (22.4 lb)	< 75 µm (< 0.002953")
LRQ600DL-E01T3A	35 N (7.8 lb)	(± 30%) 14 N (3.1 lb)	35 N (7.8 lb)	< 75 µm (< 0.002953")
LRQ600HL-E01T3A	500 N (112.1 lb)	(± 30%) 93 N (20.9 lb)	200 N (44.9 lb)	< 75 µm (< 0.002953")
LRQ075AP-E01T3A	230 N (51.6 lb)	Non-back-driving	100 N (22.4 lb)	< 20 µm (< 0.000787")
LRQ075BP-E01T3A	150 N (33.6 lb)	(± 30%) 123 N (27.6 lb)	100 N (22.4 lb)	< 20 µm (< 0.000787")

Part Number	Peak Thrust	Back-driving Force*	Maximum Continuous Thrust	Vertical Runout
LRQ075DP-E01T3A	35 N (7.8 lb)	(± 30%) 45 N (10.1 lb)	35 N (7.8 lb)	< 20 µm (< 0.000787")
LRQ075HP-E01T3A	500 N (112.1 lb)	(± 30%) 123 N (27.6 lb)	200 N (44.9 lb)	< 20 µm (< 0.000787")
LRQ150AP-E01T3A	230 N (51.6 lb)	Non-back-driving	100 N (22.4 lb)	< 25 µm (< 0.000984")
LRQ150BP-E01T3A	150 N (33.6 lb)	(± 30%) 123 N (27.6 lb)	100 N (22.4 lb)	< 25 µm (< 0.000984")
LRQ150DP-E01T3A	35 N (7.8 lb)	(± 30%) 45 N (10.1 lb)	35 N (7.8 lb)	< 25 µm (< 0.000984")
LRQ150HP-E01T3A	500 N (112.1 lb)	(± 30%) 123 N (27.6 lb)	200 N (44.9 lb)	< 25 µm (< 0.000984")
LRQ300AP-E01T3A	230 N (51.6 lb)	Non-back-driving	100 N (22.4 lb)	< 35 µm (< 0.001378")
LRQ300BP-E01T3A	150 N (33.6 lb)	(± 30%) 123 N (27.6 lb)	100 N (22.4 lb)	< 35 µm (< 0.001378")
LRQ300DP-E01T3A	35 N (7.8 lb)	(± 30%) 45 N (10.1 lb)	35 N (7.8 lb)	< 35 µm (< 0.001378")
LRQ300HP-E01T3A	500 N (112.1 lb)	(± 30%) 123 N (27.6 lb)	200 N (44.9 lb)	< 35 µm (< 0.001378")
LRQ450AP-E01T3A	230 N (51.6 lb)	Non-back-driving	100 N (22.4 lb)	< 45 µm (< 0.001772")
LRQ450BP-E01T3A	150 N (33.6 lb)	(± 30%) 123 N (27.6 lb)	100 N (22.4 lb)	< 45 µm (< 0.001772")
LRQ450DP-E01T3A	35 N (7.8 lb)	(± 30%) 45 N (10.1 lb)	35 N (7.8 lb)	< 45 µm (< 0.001772")
LRQ450HP-E01T3A	500 N (112.1 lb)	(± 30%) 123 N (27.6 lb)	200 N (44.9 lb)	< 45 µm (< 0.001772")
LRQ600AP-E01T3A	230 N (51.6 lb)	Non-back-driving	100 N (22.4 lb)	< 75 µm (< 0.002953")
LRQ600BP-E01T3A	150 N (33.6 lb)	(± 30%) 123 N (27.6 lb)	100 N (22.4 lb)	< 75 µm (< 0.002953")
LRQ600DP-E01T3A	35 N (7.8 lb)	(± 30%) 45 N (10.1 lb)	35 N (7.8 lb)	< 75 µm (< 0.002953")
LRQ600HP-E01T3A	500 N (112.1 lb)	(± 30%) 123 N (27.6 lb)	200 N (44.9 lb)	< 75 µm (< 0.002953")

Part Number	Horizontal Runout	Pitch	Roll	Yaw
LRQ075AL-E01T3A	< 20 µm (< 0.000787")	0.025° (0.436 mrad)	0.015° (0.262 mrad)	0.02° (0.349 mrad)
	< 20 µm	0.025°	0.015°	0.02°

Part Number	Horizontal Runout	Pitch	Roll	Yaw
LRQ075BL-E01T3A	(< 0.000787")	(0.436 mrad)	(0.262 mrad)	(0.349 mrad)
LRQ075DL-E01T3A	< 20 μm (< 0.000787")	0.025° (0.436 mrad)	0.015° (0.262 mrad)	0.02° (0.349 mrad)
LRQ075HL-E01T3A	< 20 μm (< 0.000787")	0.025° (0.436 mrad)	0.015° (0.262 mrad)	0.02° (0.349 mrad)
LRQ150AL-E01T3A	< 20 μm (< 0.000787")	0.03° (0.523 mrad)	0.015° (0.262 mrad)	0.02° (0.349 mrad)
LRQ150BL-E01T3A	< 20 μm (< 0.000787")	0.03° (0.523 mrad)	0.015° (0.262 mrad)	0.02° (0.349 mrad)
LRQ150DL-E01T3A	< 20 μm (< 0.000787")	0.03° (0.523 mrad)	0.015° (0.262 mrad)	0.02° (0.349 mrad)
LRQ150HL-E01T3A	< 20 μm (< 0.000787")	0.03° (0.523 mrad)	0.015° (0.262 mrad)	0.02° (0.349 mrad)
LRQ300AL-E01T3A	< 30 μm (< 0.001181")	0.034° (0.593 mrad)	0.015° (0.262 mrad)	0.03° (0.523 mrad)
LRQ300BL-E01T3A	< 30 μm (< 0.001181")	0.034° (0.593 mrad)	0.015° (0.262 mrad)	0.03° (0.523 mrad)
LRQ300DL-E01T3A	< 30 μm (< 0.001181")	0.034° (0.593 mrad)	0.015° (0.262 mrad)	0.03° (0.523 mrad)
LRQ300HL-E01T3A	< 30 μm (< 0.001181")	0.034° (0.593 mrad)	0.015° (0.262 mrad)	0.03° (0.523 mrad)
LRQ450AL-E01T3A	< 40 μm (< 0.001575")	0.04° (0.698 mrad)	0.025° (0.436 mrad)	0.04° (0.698 mrad)
LRQ450BL-E01T3A	< 40 μm (< 0.001575")	0.04° (0.698 mrad)	0.025° (0.436 mrad)	0.04° (0.698 mrad)
LRQ450DL-E01T3A	< 40 μm (< 0.001575")	0.04° (0.698 mrad)	0.025° (0.436 mrad)	0.04° (0.698 mrad)
LRQ450HL-E01T3A	< 40 μm (< 0.001575")	0.04° (0.698 mrad)	0.025° (0.436 mrad)	0.04° (0.698 mrad)
LRQ600AL-E01T3A	< 60 μm (< 0.002362")	0.045° (0.785 mrad)	0.035° (0.611 mrad)	0.04° (0.698 mrad)
LRQ600BL-E01T3A	< 60 μm (< 0.002362")	0.045° (0.785 mrad)	0.035° (0.611 mrad)	0.04° (0.698 mrad)
LRQ600DL-E01T3A	< 60 μm (< 0.002362")	0.045° (0.785 mrad)	0.035° (0.611 mrad)	0.04° (0.698 mrad)
LRQ600HL-E01T3A	< 60 μm (< 0.002362")	0.045° (0.785 mrad)	0.035° (0.611 mrad)	0.04° (0.698 mrad)
LRQ075AP-E01T3A	< 20 μm (< 0.000787")	0.025° (0.436 mrad)	0.015° (0.262 mrad)	0.02° (0.349 mrad)
LRQ075BP-E01T3A	< 20 μm (< 0.000787")	0.025° (0.436 mrad)	0.015° (0.262 mrad)	0.02° (0.349 mrad)
LRQ075DP-E01T3A	< 20 μm	0.025°	0.015°	0.02°

Part Number	Horizontal Runout	Pitch	Roll	Yaw
	(< 0.000787")	(0.436 mrad)	(0.262 mrad)	(0.349 mrad)
LRQ075HP-E01T3A	< 20 µm (< 0.000787")	0.025° (0.436 mrad)	0.015° (0.262 mrad)	0.02° (0.349 mrad)
LRQ150AP-E01T3A	< 20 µm (< 0.000787")	0.03° (0.523 mrad)	0.015° (0.262 mrad)	0.02° (0.349 mrad)
LRQ150BP-E01T3A	< 20 µm (< 0.000787")	0.03° (0.523 mrad)	0.015° (0.262 mrad)	0.02° (0.349 mrad)
LRQ150DP-E01T3A	< 20 µm (< 0.000787")	0.03° (0.523 mrad)	0.015° (0.262 mrad)	0.02° (0.349 mrad)
LRQ150HP-E01T3A	< 20 µm (< 0.000787")	0.03° (0.523 mrad)	0.015° (0.262 mrad)	0.02° (0.349 mrad)
LRQ300AP-E01T3A	< 30 µm (< 0.001181")	0.034° (0.593 mrad)	0.015° (0.262 mrad)	0.03° (0.523 mrad)
LRQ300BP-E01T3A	< 30 µm (< 0.001181")	0.034° (0.593 mrad)	0.015° (0.262 mrad)	0.03° (0.523 mrad)
LRQ300DP-E01T3A	< 30 µm (< 0.001181")	0.034° (0.593 mrad)	0.015° (0.262 mrad)	0.03° (0.523 mrad)
LRQ300HP-E01T3A	< 30 µm (< 0.001181")	0.034° (0.593 mrad)	0.015° (0.262 mrad)	0.03° (0.523 mrad)
LRQ450AP-E01T3A	< 40 µm (< 0.001575")	0.04° (0.698 mrad)	0.025° (0.436 mrad)	0.04° (0.698 mrad)
LRQ450BP-E01T3A	< 40 µm (< 0.001575")	0.04° (0.698 mrad)	0.025° (0.436 mrad)	0.04° (0.698 mrad)
LRQ450DP-E01T3A	< 40 µm (< 0.001575")	0.04° (0.698 mrad)	0.025° (0.436 mrad)	0.04° (0.698 mrad)
LRQ450HP-E01T3A	< 40 µm (< 0.001575")	0.04° (0.698 mrad)	0.025° (0.436 mrad)	0.04° (0.698 mrad)
LRQ600AP-E01T3A	< 60 µm (< 0.002362")	0.045° (0.785 mrad)	0.035° (0.611 mrad)	0.04° (0.698 mrad)
LRQ600BP-E01T3A	< 60 µm (< 0.002362")	0.045° (0.785 mrad)	0.035° (0.611 mrad)	0.04° (0.698 mrad)
LRQ600DP-E01T3A	< 60 µm (< 0.002362")	0.045° (0.785 mrad)	0.035° (0.611 mrad)	0.04° (0.698 mrad)
LRQ600HP-E01T3A	< 60 µm (< 0.002362")	0.045° (0.785 mrad)	0.035° (0.611 mrad)	0.04° (0.698 mrad)

Part Number	Linear Motion Per Motor Rev	Mechanical Drive System	Weight
LRQ075AL-E01T3A	1.27 mm (0.050")	Precision lead screw	2.15 kg (4.740 lb)
LRQ075BL-E01T3A	6.35 mm (0.250")	Precision lead screw	2.15 kg (4.740 lb)
LRQ075DL-E01T3A	25.4 mm (1.000")	Precision lead screw	2.15 kg (4.740 lb)

Part Number	Linear Motion Per Motor Rev	Mechanical Drive System	Weight
LRQ075HL-E01T3A	2.5 mm (0.098")	Precision ball screw	2.15 kg (4.740 lb)
LRQ150AL-E01T3A	1.27 mm (0.050")	Precision lead screw	2.52 kg (5.556 lb)
LRQ150BL-E01T3A	6.35 mm (0.250")	Precision lead screw	2.52 kg (5.556 lb)
LRQ150DL-E01T3A	25.4 mm (1.000")	Precision lead screw	2.52 kg (5.556 lb)
LRQ150HL-E01T3A	2.5 mm (0.098")	Precision ball screw	2.52 kg (5.556 lb)
LRQ300AL-E01T3A	1.27 mm (0.050")	Precision lead screw	3.28 kg (7.231 lb)
LRQ300BL-E01T3A	6.35 mm (0.250")	Precision lead screw	3.28 kg (7.231 lb)
LRQ300DL-E01T3A	25.4 mm (1.000")	Precision lead screw	3.28 kg (7.231 lb)
LRQ300HL-E01T3A	2.5 mm (0.098")	Precision ball screw	3.28 kg (7.231 lb)
LRQ450AL-E01T3A	1.27 mm (0.050")	Precision lead screw	4.03 kg (8.885 lb)
LRQ450BL-E01T3A	6.35 mm (0.250")	Precision lead screw	4.03 kg (8.885 lb)
LRQ450DL-E01T3A	25.4 mm (1.000")	Precision lead screw	4.03 kg (8.885 lb)
LRQ450HL-E01T3A	2.5 mm (0.098")	Precision ball screw	4.03 kg (8.885 lb)
LRQ600AL-E01T3A	1.27 mm (0.050")	Precision lead screw	4.74 kg (10.450 lb)
LRQ600BL-E01T3A	6.35 mm (0.250")	Precision lead screw	4.74 kg (10.450 lb)
LRQ600DL-E01T3A	25.4 mm (1.000")	Precision lead screw	4.74 kg (10.450 lb)
LRQ600HL-E01T3A	2.5 mm (0.098")	Precision ball screw	4.74 kg (10.450 lb)
LRQ075AP-E01T3A	1.27 mm (0.050")	Precision lead screw	2.29 kg (5.049 lb)
LRQ075BP-E01T3A	6.35 mm (0.250")	Precision lead screw	2.29 kg (5.049 lb)
LRQ075DP-E01T3A	6.35 mm (0.250")	Precision lead screw	2.29 kg (5.049 lb)
LRQ075HP-E01T3A	2.5 mm (0.098")	Precision ball screw	2.29 kg (5.049 lb)
LRQ150AP-E01T3A	1.27 mm (0.050")	Precision lead screw	2.66 kg (5.864 lb)
LRQ150BP-E01T3A	6.35 mm (0.250")	Precision lead screw	2.66 kg (5.864 lb)
LRQ150DP-E01T3A	25.4 mm (1.000")	Precision lead screw	2.66 kg (5.864 lb)
LRQ150HP-E01T3A	2.5 mm (0.098")	Precision ball screw	2.66 kg (5.864 lb)
LRQ300AP-E01T3A	1.27 mm (0.050")	Precision lead screw	3.42 kg (7.540 lb)
LRQ300BP-E01T3A	6.35 mm (0.250")	Precision lead screw	3.42 kg (7.540 lb)
LRQ300DP-E01T3A	25.4 mm (1.000")	Precision lead screw	3.42 kg (7.540 lb)
LRQ300HP-E01T3A	2.5 mm (0.098")	Precision ball screw	3.42 kg (7.540 lb)
LRQ450AP-E01T3A	1.27 mm (0.050")	Precision lead screw	4.17 kg (9.193 lb)
LRQ450BP-E01T3A	6.35 mm (0.250")	Precision lead screw	4.17 kg (9.193 lb)
LRQ450DP-E01T3A	25.4 mm (1.000")	Precision lead screw	4.17 kg (9.193 lb)
LRQ450HP-E01T3A	2.5 mm (0.098")	Precision ball screw	4.17 kg (9.193 lb)

Part Number	Linear Motion Per Motor Rev	Mechanical Drive System	Weight
LRQ600AP-E01T3A	1.27 mm (0.050")	Precision lead screw	4.88 kg (10.759 lb)
LRQ600BP-E01T3A	6.35 mm (0.250")	Precision lead screw	4.88 kg (10.759 lb)
LRQ600DP-E01T3A	25.4 mm (1.000")	Precision lead screw	4.88 kg (10.759 lb)
LRQ600HP-E01T3A	2.5 mm (0.098")	Precision ball screw	4.88 kg (10.759 lb)

LRQ-E Series Charts

Thrust Speed Performance

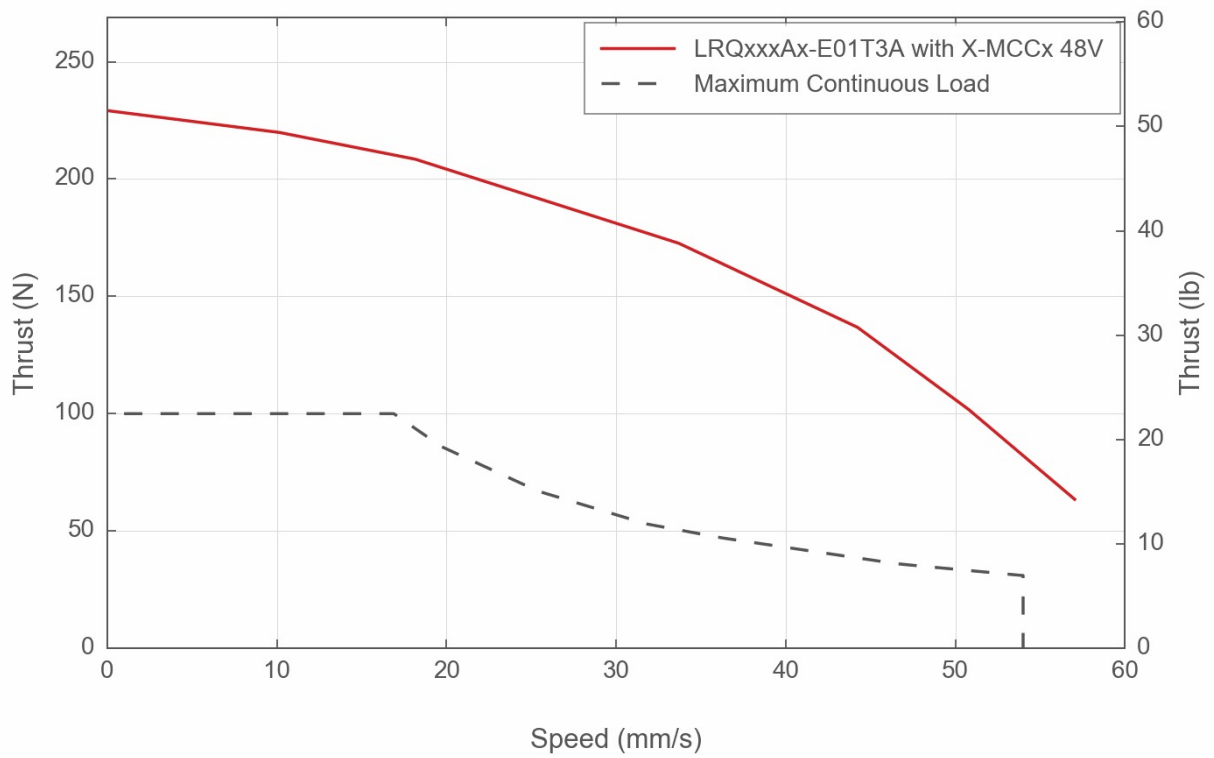

Thrust Speed Performance

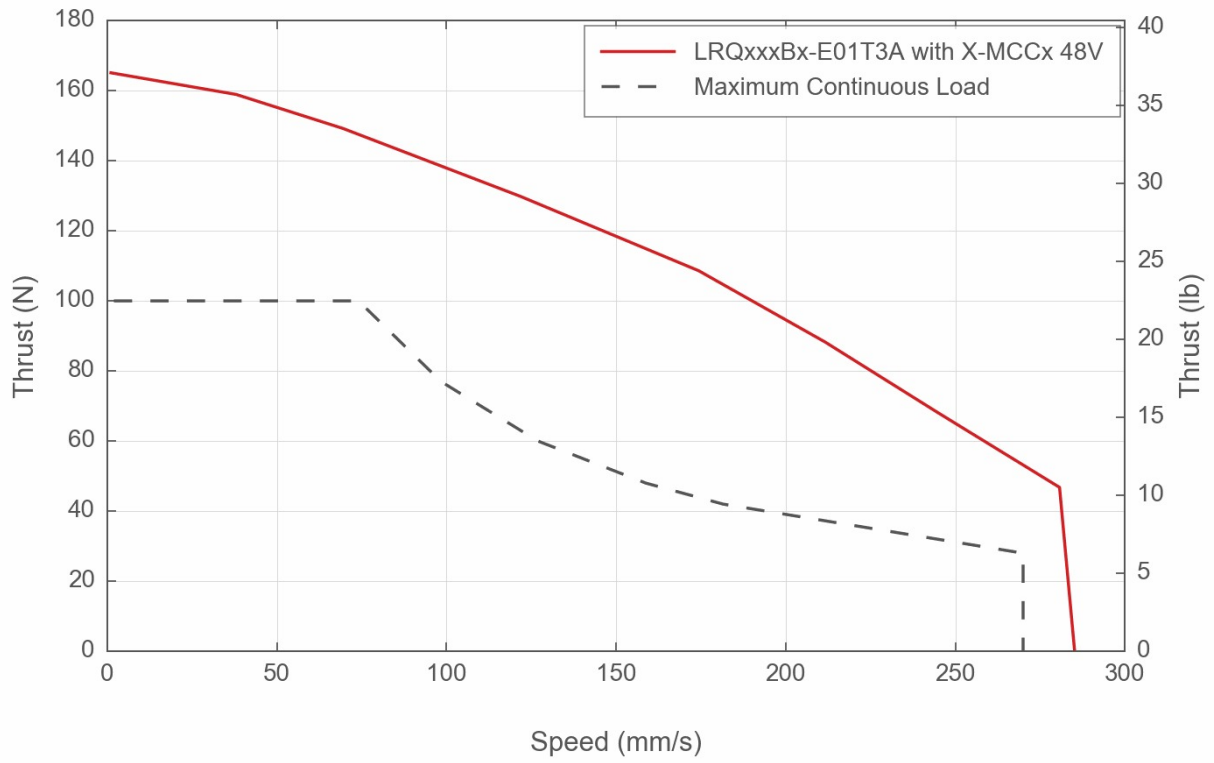

Thrust Speed Performance

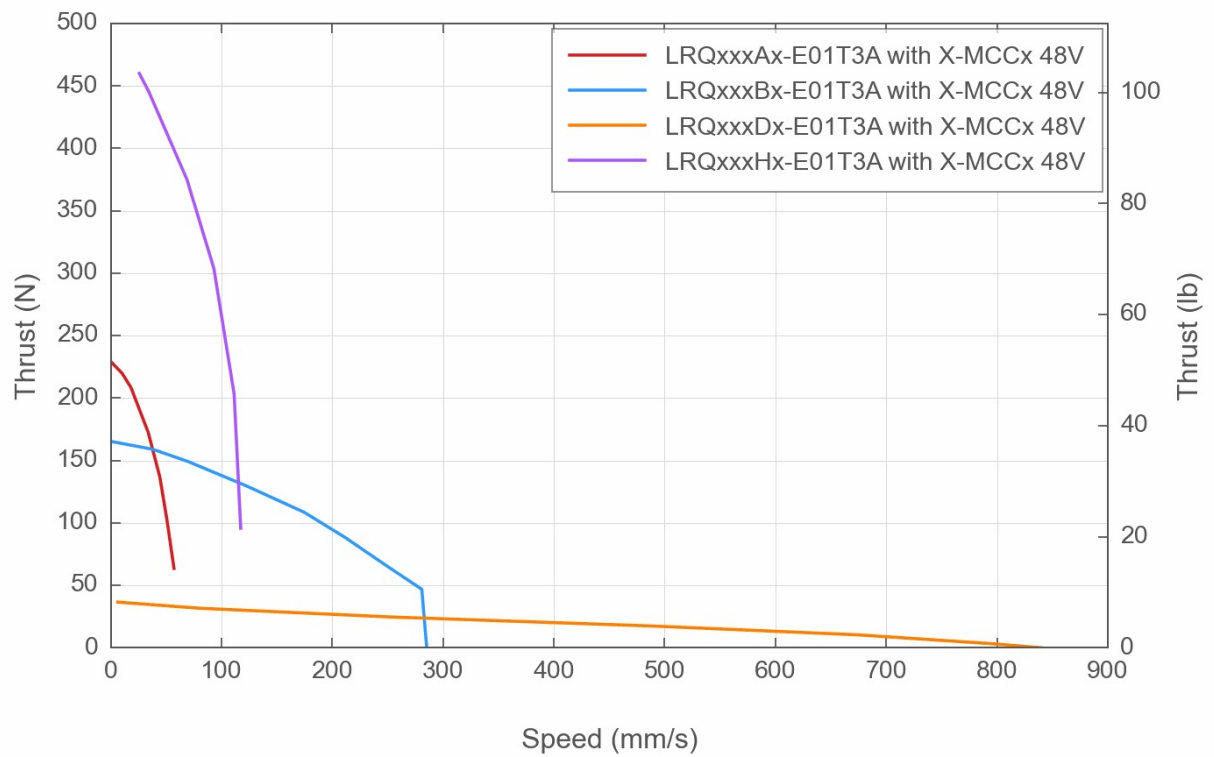

Thrust Speed Performance

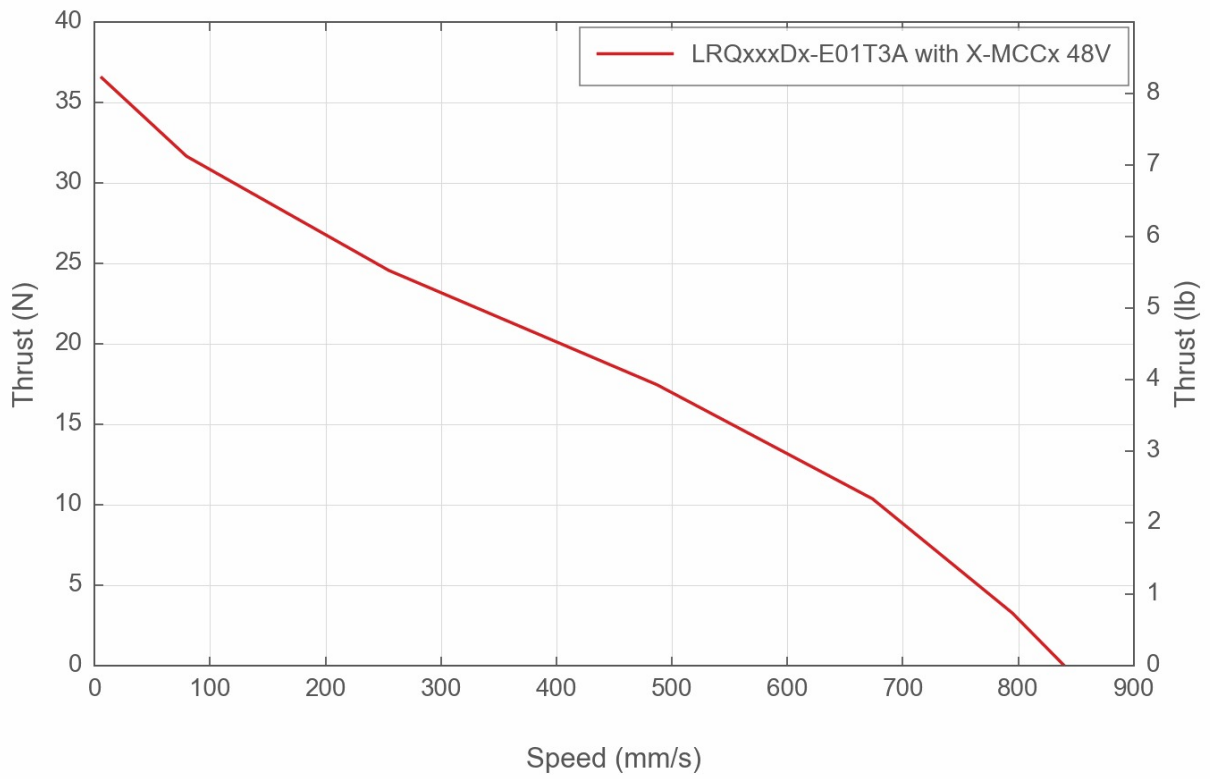

LRQ Linear Bearing Lifetime

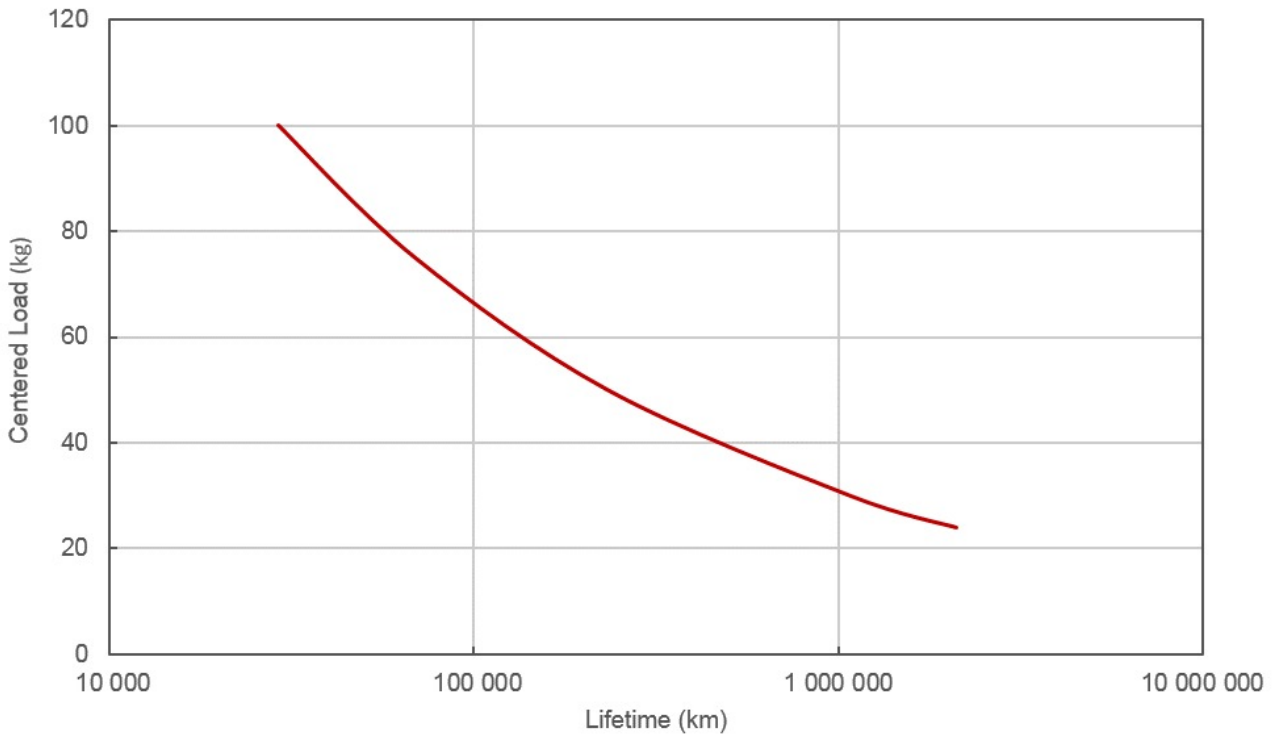

Thrust Speed Performance

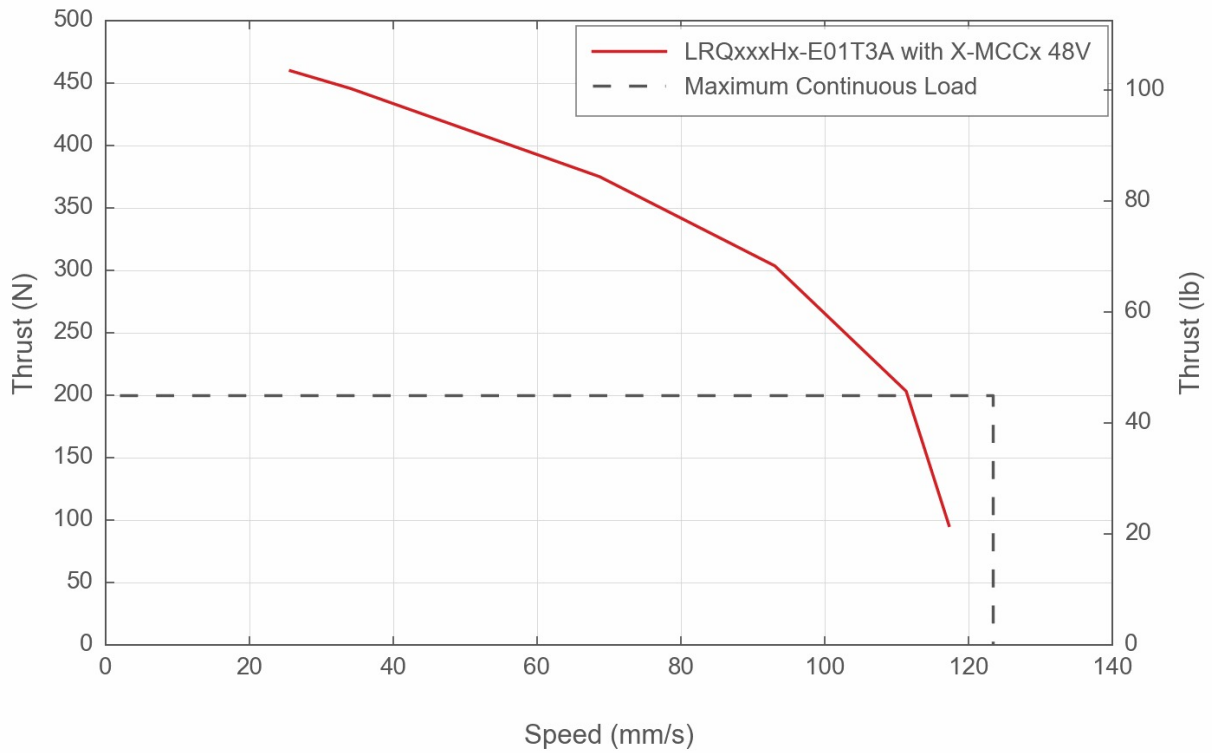

Contact

Email: contact@zaber.com

Phone (toll free Canada/USA): 1-888-276-8033

Phone (direct): 1-604-569-3780

Fax: 1-604-648-8033

Zaber Technologies Inc.

#2 - 605 West Kent Ave. N.

Vancouver, British Columbia

Canada, V6P 6T7

<https://www.zaber.com>