

## LRQ-DE Series Datasheet



- 75, 150, 300, 450, 600 mm travel
- Up to 10  $\mu\text{m}$  accuracy over 600 mm travel
- Up to 270 mm/s speed and up to 500 N thrust
- 100 kg load capacity
- Inline and parallel drive configurations
- Ball screw and lead screw configurations
- Integrated linear encoders with 50 nm resolution provide slip/stall detection and position correction
- Designed for use with an X-MCC Series stepper motor controller or any 2-phase stepper motor controller
- With AutoDetect, the X-MCC controller configures its settings automatically for the connected peripheral
- Custom versions available

## LRQ-DE Series Overview

Zaber's LRQ-DE Series products are computer-controlled, motorized linear stages with high stiffness, load, and lifetime capabilities in a compact size. An integrated linear encoder combined with stage calibration provides high accuracy positioning over the full travel of the device. At only 36 mm high, these stages are excellent for applications where a low profile is required. These stages are capable of speeds up to 270 mm/s, and can bolt together into XY and XYZ systems. Some multi axis configurations may require additional accessories, please contact Zaber Technical Support to ensure the correct ones are selected. Each device is available in either an inline or parallel drive configuration.

The stages are designed to connect directly to our X-MCC Series universal motor controllers, or they can be used with any 2-phase stepper motor controller through the panel mount DB26 connector. Set up is easy with AutoDetect. Once connected, the X-MCC controller will automatically detect and configure the LRQ-DE.

For more information visit: <https://www.zaber.com/products/linear-stages/LRQ-DE>

## LRQ-DE Series Part Numbering & Options

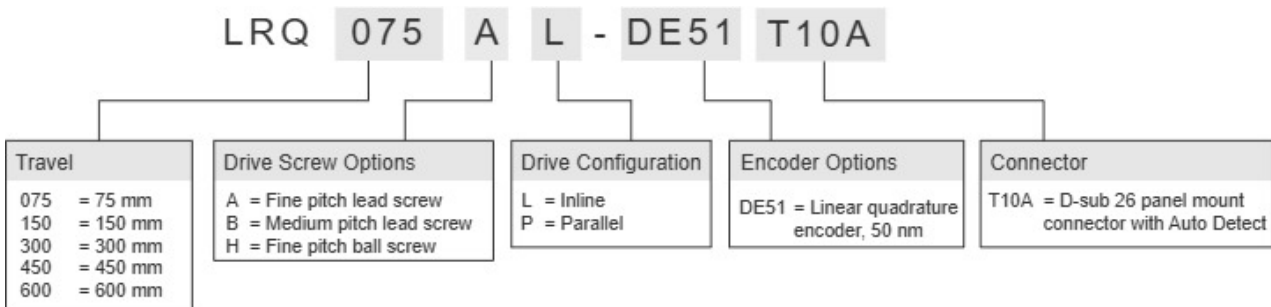

## LRQ-DE Series Drawings

- [LRQxL-DET10A.png \(Drawing for the LRQxL-DET10A\)](#)
- [LRQxP-DET10A.png \(Drawing for the LRQxP-DET10A\)](#)

## LRQ-DE Series Specifications

<b>Built-in Controller</b>	
Recommended Controller	X-MCC (48 V) Recommended
AutoDetect	Yes
Repeatability	< 2 $\mu\text{m}$ (< 0.000079")
Encoder Type	Linear quadrature encoder
Encoder Resolution	50 nm
Maximum Centered Load	1000 N (224.3 lb)
Maximum Moment (Pitch)	30 N-m (22.1 ft-lb)
Maximum Moment (Roll)	30 N-m (22.1 ft-lb)
Maximum Moment (Yaw)	30 N-m (22.1 ft-lb)
Stiffness in Pitch	500 N-m/ $^{\circ}$ (35 $\mu\text{rad/N-m}$ )
Stiffness in Roll	1180 N-m/ $^{\circ}$ (15 $\mu\text{rad/N-m}$ )
Stiffness in Yaw	450 N-m/ $^{\circ}$ (39 $\mu\text{rad/N-m}$ )
Motor Steps Per Rev	200
Motor Type	Stepper (2 phase)
Motor Rated Current	2300 mA/phase
Motor Winding Resistance	1 ohms/phase
Inductance	2.2 mH/phase
Motor Connection	D-sub 26
Default Resolution	1/64 of a step
Guide Type	Recirculating Ball Linear Guide
Limit or Home Sensing	Magnetic home sensor
Axes of Motion	1
Mounting Interface	M6 and M3 threaded holes
Operating Temperature Range	0 to 50 $^{\circ}\text{C}$
CE Compliant	Yes
Vacuum Compatible	No

<b>Part Number</b>	<b>Microstep Size (Default Resolution)</b>	<b>Travel Range</b>	<b>Accuracy (unidirectional)</b>	<b>Backlash</b>
LRQ075AL-DE51T10A	0.09921875 $\mu\text{m}$	75 mm (2.953")	10 $\mu\text{m}$	< 5 $\mu\text{m}$

Part Number	Microstep Size (Default Resolution)	Travel Range	Accuracy (unidirectional)	Backlash
			(0.000394")	(< 0.000197")
LRQ075BL-DE51T10A	0.49609375 µm	75 mm (2.953")	13 µm (0.000512")	< 6.5 µm (< 0.000256")
LRQ075HL-DE51T10A	0.1953125 µm	75 mm (2.953")	13 µm (0.000512")	< 6.5 µm (< 0.000256")
LRQ150AL-DE51T10A	0.09921875 µm	150 mm (5.905")	10 µm (0.000394")	< 5 µm (< 0.000197")
LRQ150BL-DE51T10A	0.49609375 µm	150 mm (5.905")	13 µm (0.000512")	< 6.5 µm (< 0.000256")
LRQ150HL-DE51T10A	0.1953125 µm	150 mm (5.905")	13 µm (0.000512")	< 6.5 µm (< 0.000256")
LRQ300AL-DE51T10A	0.09921875 µm	300 mm (11.811")	10 µm (0.000394")	< 5 µm (< 0.000197")
LRQ300BL-DE51T10A	0.49609375 µm	300 mm (11.811")	13 µm (0.000512")	< 6.5 µm (< 0.000256")
LRQ300HL-DE51T10A	0.1953125 µm	300 mm (11.811")	13 µm (0.000512")	< 6.5 µm (< 0.000256")
LRQ450AL-DE51T10A	0.09921875 µm	450 mm (17.716")	10 µm (0.000394")	< 5 µm (< 0.000197")
LRQ450BL-DE51T10A	0.49609375 µm	450 mm (17.716")	13 µm (0.000512")	< 6.5 µm (< 0.000256")
LRQ450HL-DE51T10A	0.1953125 µm	450 mm (17.716")	13 µm (0.000512")	< 6.5 µm (< 0.000256")
LRQ600AL-DE51T10A	0.09921875 µm	600 mm (23.622")	10 µm (0.000394")	< 5 µm (< 0.000197")
LRQ600BL-DE51T10A	0.49609375 µm	600 mm (23.622")	13 µm (0.000512")	< 6.5 µm (< 0.000256")
LRQ600HL-DE51T10A	0.1953125 µm	600 mm (23.622")	13 µm (0.000512")	< 6.5 µm (< 0.000256")
LRQ075AP-DE51T10A	0.09921875 µm	75 mm (2.953")	10 µm (0.000394")	< 5 µm (< 0.000197")
LRQ075BP-DE51T10A	0.49609375 µm	75 mm (2.953")	13 µm (0.000512")	< 6.5 µm (< 0.000256")
LRQ075HP-DE51T10A	0.1953125 µm	75 mm (2.953")	13 µm (0.000512")	< 6.5 µm (< 0.000256")
LRQ150AP-DE51T10A	0.09921875 µm	150 mm (5.905")	10 µm (0.000394")	< 5 µm (< 0.000197")
LRQ150BP-DE51T10A	0.49609375 µm	150 mm (5.905")	13 µm (0.000512")	< 6.5 µm (< 0.000256")
LRQ150HP-DE51T10A	0.1953125 µm	150 mm (5.905")	13 µm (0.000512")	< 6.5 µm (< 0.000256")

Part Number	Microstep Size (Default Resolution)	Travel Range	Accuracy (unidirectional)	Backlash
LRQ300AP-DE51T10A	0.09921875 µm	300 mm (11.811")	10 µm (0.000394")	< 5 µm (< 0.000197")
LRQ300BP-DE51T10A	0.49609375 µm	300 mm (11.811")	13 µm (0.000512")	< 6.5 µm (< 0.000256")
LRQ300HP-DE51T10A	0.1953125 µm	300 mm (11.811")	13 µm (0.000512")	< 6.5 µm (< 0.000256")
LRQ450AP-DE51T10A	0.09921875 µm	450 mm (17.716")	10 µm (0.000394")	< 5 µm (< 0.000197")
LRQ450BP-DE51T10A	0.49609375 µm	450 mm (17.716")	13 µm (0.000512")	< 6.5 µm (< 0.000256")
LRQ450HP-DE51T10A	0.1953125 µm	450 mm (17.716")	13 µm (0.000512")	< 6.5 µm (< 0.000256")
LRQ600AP-DE51T10A	0.09921875 µm	600 mm (23.622")	10 µm (0.000394")	< 5 µm (< 0.000197")
LRQ600BP-DE51T10A	0.49609375 µm	600 mm (23.622")	13 µm (0.000512")	< 6.5 µm (< 0.000256")
LRQ600HP-DE51T10A	0.1953125 µm	600 mm (23.622")	13 µm (0.000512")	< 6.5 µm (< 0.000256")

Part Number	Maximum Speed	Minimum Speed	Speed Resolution	Peak Thrust
LRQ075AL-DE51T10A	54 mm/s (2.126"/s)	0.000061 mm/s (0.000002"/s)	0.000061 mm/s (0.000002"/s)	230 N (51.6 lb)
LRQ075BL-DE51T10A	270 mm/s (10.630"/s)	0.000303 mm/s (0.000012"/s)	0.000303 mm/s (0.000012"/s)	150 N (33.6 lb)
LRQ075HL-DE51T10A	110 mm/s (4.331"/s)	0.000119 mm/s (0.000005"/s)	0.000119 mm/s (0.000005"/s)	500 N (112.1 lb)
LRQ150AL-DE51T10A	54 mm/s (2.126"/s)	0.000061 mm/s (0.000002"/s)	0.000061 mm/s (0.000002"/s)	230 N (51.6 lb)
LRQ150BL-DE51T10A	270 mm/s (10.630"/s)	0.000303 mm/s (0.000012"/s)	0.000303 mm/s (0.000012"/s)	150 N (33.6 lb)
LRQ150HL-DE51T10A	110 mm/s (4.331"/s)	0.000119 mm/s (0.000005"/s)	0.000119 mm/s (0.000005"/s)	500 N (112.1 lb)
LRQ300AL-DE51T10A	54 mm/s (2.126"/s)	0.000061 mm/s (0.000002"/s)	0.000061 mm/s (0.000002"/s)	230 N (51.6 lb)
LRQ300BL-DE51T10A	270 mm/s (10.630"/s)	0.000303 mm/s (0.000012"/s)	0.000303 mm/s (0.000012"/s)	150 N (33.6 lb)
LRQ300HL-DE51T10A	110 mm/s (4.331"/s)	0.000119 mm/s (0.000005"/s)	0.000119 mm/s (0.000005"/s)	500 N (112.1 lb)
LRQ450AL-DE51T10A	54 mm/s (2.126"/s)	0.000061 mm/s (0.000002"/s)	0.000061 mm/s (0.000002"/s)	230 N (51.6 lb)
	270 mm/s	0.000303 mm/s	0.000303 mm/s	

Part Number	Maximum Speed	Minimum Speed	Speed Resolution	Peak Thrust
LRQ450BL-DE51T10A	(10.630"/s)	(0.000012"/s)	(0.000012"/s)	150 N (33.6 lb)
LRQ450HL-DE51T10A	110 mm/s (4.331"/s)	0.000119 mm/s (0.000005"/s)	0.000119 mm/s (0.000005"/s)	500 N (112.1 lb)
LRQ600AL-DE51T10A	54 mm/s (2.126"/s)	0.000061 mm/s (0.000002"/s)	0.000061 mm/s (0.000002"/s)	230 N (51.6 lb)
LRQ600BL-DE51T10A	270 mm/s (10.630"/s)	0.000303 mm/s (0.000012"/s)	0.000303 mm/s (0.000012"/s)	150 N (33.6 lb)
LRQ600HL-DE51T10A	110 mm/s (4.331"/s)	0.000119 mm/s (0.000005"/s)	0.000119 mm/s (0.000005"/s)	500 N (112.1 lb)
LRQ075AP-DE51T10A	54 mm/s (2.126"/s)	0.000061 mm/s (0.000002"/s)	0.000061 mm/s (0.000002"/s)	230 N (51.6 lb)
LRQ075BP-DE51T10A	270 mm/s (10.630"/s)	0.000303 mm/s (0.000012"/s)	0.000303 mm/s (0.000012"/s)	150 N (33.6 lb)
LRQ075HP-DE51T10A	110 mm/s (4.331"/s)	0.000119 mm/s (0.000005"/s)	0.000119 mm/s (0.000005"/s)	500 N (112.1 lb)
LRQ150AP-DE51T10A	54 mm/s (2.126"/s)	0.000061 mm/s (0.000002"/s)	0.000061 mm/s (0.000002"/s)	230 N (51.6 lb)
LRQ150BP-DE51T10A	270 mm/s (10.630"/s)	0.000303 mm/s (0.000012"/s)	0.000303 mm/s (0.000012"/s)	150 N (33.6 lb)
LRQ150HP-DE51T10A	110 mm/s (4.331"/s)	0.000119 mm/s (0.000005"/s)	0.000119 mm/s (0.000005"/s)	500 N (112.1 lb)
LRQ300AP-DE51T10A	54 mm/s (2.126"/s)	0.000061 mm/s (0.000002"/s)	0.000061 mm/s (0.000002"/s)	230 N (51.6 lb)
LRQ300BP-DE51T10A	270 mm/s (10.630"/s)	0.000303 mm/s (0.000012"/s)	0.000303 mm/s (0.000012"/s)	150 N (33.6 lb)
LRQ300HP-DE51T10A	110 mm/s (4.331"/s)	0.000119 mm/s (0.000005"/s)	0.000119 mm/s (0.000005"/s)	500 N (112.1 lb)
LRQ450AP-DE51T10A	54 mm/s (2.126"/s)	0.000061 mm/s (0.000002"/s)	0.000061 mm/s (0.000002"/s)	230 N (51.6 lb)
LRQ450BP-DE51T10A	270 mm/s (10.630"/s)	0.000303 mm/s (0.000012"/s)	0.000303 mm/s (0.000012"/s)	150 N (33.6 lb)
LRQ450HP-DE51T10A	110 mm/s (4.331"/s)	0.000119 mm/s (0.000005"/s)	0.000119 mm/s (0.000005"/s)	500 N (112.1 lb)
LRQ600AP-DE51T10A	54 mm/s (2.126"/s)	0.000061 mm/s (0.000002"/s)	0.000061 mm/s (0.000002"/s)	230 N (51.6 lb)
LRQ600BP-DE51T10A	270 mm/s (10.630"/s)	0.000303 mm/s (0.000012"/s)	0.000303 mm/s (0.000012"/s)	150 N (33.6 lb)
LRQ600HP-DE51T10A	110 mm/s (4.331"/s)	0.000119 mm/s (0.000005"/s)	0.000119 mm/s (0.000005"/s)	500 N (112.1 lb)

Part Number	Back-driving Force*	Maximum Continuous Thrust	Vertical Runout	Horizontal Runout
LRQ075AL-DE51T10A	Non-back-driving	100 N (22.4 lb)	< 20 µm (< 0.000787")	< 20 µm (< 0.000787")
LRQ075BL-DE51T10A	(± 30%) 93 N (20.9 lb)	100 N (22.4 lb)	< 20 µm (< 0.000787")	< 20 µm (< 0.000787")
LRQ075HL-DE51T10A	(± 30%) 93 N (20.9 lb)	200 N (44.9 lb)	< 20 µm (< 0.000787")	< 20 µm (< 0.000787")
LRQ150AL-DE51T10A	Non-back-driving	100 N (22.4 lb)	< 25 µm (< 0.000984")	< 20 µm (< 0.000787")
LRQ150BL-DE51T10A	(± 30%) 93 N (20.9 lb)	100 N (22.4 lb)	< 25 µm (< 0.000984")	< 20 µm (< 0.000787")
LRQ150HL-DE51T10A	(± 30%) 93 N (20.9 lb)	200 N (44.9 lb)	< 25 µm (< 0.000984")	< 20 µm (< 0.000787")
LRQ300AL-DE51T10A	Non-back-driving	100 N (22.4 lb)	< 35 µm (< 0.001378")	< 30 µm (< 0.001181")
LRQ300BL-DE51T10A	(± 30%) 93 N (20.9 lb)	100 N (22.4 lb)	< 35 µm (< 0.001378")	< 30 µm (< 0.001181")
LRQ300HL-DE51T10A	(± 30%) 93 N (20.9 lb)	200 N (44.9 lb)	< 35 µm (< 0.001378")	< 30 µm (< 0.001181")
LRQ450AL-DE51T10A	Non-back-driving	100 N (22.4 lb)	< 45 µm (< 0.001772")	< 40 µm (< 0.001575")
LRQ450BL-DE51T10A	(± 30%) 93 N (20.9 lb)	100 N (22.4 lb)	< 45 µm (< 0.001772")	< 40 µm (< 0.001575")
LRQ450HL-DE51T10A	(± 30%) 93 N (20.9 lb)	200 N (44.9 lb)	< 45 µm (< 0.001772")	< 40 µm (< 0.001575")
LRQ600AL-DE51T10A	Non-back-driving	100 N (22.4 lb)	< 75 µm (< 0.002953")	< 60 µm (< 0.002362")
LRQ600BL-DE51T10A	(± 30%) 93 N (20.9 lb)	100 N (22.4 lb)	< 75 µm (< 0.002953")	< 60 µm (< 0.002362")
LRQ600HL-DE51T10A	(± 30%) 93 N (20.9 lb)	200 N (44.9 lb)	< 75 µm (< 0.002953")	< 60 µm (< 0.002362")
LRQ075AP-DE51T10A	Non-back-driving	100 N (22.4 lb)	< 20 µm (< 0.000787")	< 20 µm (< 0.000787")
LRQ075BP-DE51T10A	(± 30%) 123 N (27.6 lb)	100 N (22.4 lb)	< 20 µm (< 0.000787")	< 20 µm (< 0.000787")
LRQ075HP-DE51T10A	(± 30%) 123 N (27.6 lb)	200 N (44.9 lb)	< 20 µm (< 0.000787")	< 20 µm (< 0.000787")
LRQ150AP-DE51T10A	Non-back-driving	100 N (22.4 lb)	< 25 µm (< 0.000984")	< 20 µm (< 0.000787")
LRQ150BP-DE51T10A	(± 30%) 123 N (27.6 lb)	100 N (22.4 lb)	< 25 µm (< 0.000984")	< 20 µm (< 0.000787")
LRQ150HP-DE51T10A	(± 30%) 123 N (27.6 lb)	200 N (44.9 lb)	< 25 µm (< 0.000984")	< 20 µm (< 0.000787")
			< 35 µm	< 30 µm

Part Number	Back-driving Force*	Maximum Continuous Thrust	Vertical Runout	Horizontal Runout
LRQ300AP-DE51T10A	Non-back-driving	100 N (22.4 lb)	(< 0.001378")	(< 0.001181")
LRQ300BP-DE51T10A	(± 30%) 123 N (27.6 lb)	100 N (22.4 lb)	< 35 µm (< 0.001378")	< 30 µm (< 0.001181")
LRQ300HP-DE51T10A	(± 30%) 123 N (27.6 lb)	200 N (44.9 lb)	< 35 µm (< 0.001378")	< 30 µm (< 0.001181")
LRQ450AP-DE51T10A	Non-back-driving	100 N (22.4 lb)	< 45 µm (< 0.001772")	< 40 µm (< 0.001575")
LRQ450BP-DE51T10A	(± 30%) 123 N (27.6 lb)	100 N (22.4 lb)	< 45 µm (< 0.001772")	< 40 µm (< 0.001575")
LRQ450HP-DE51T10A	(± 30%) 123 N (27.6 lb)	200 N (44.9 lb)	< 45 µm (< 0.001772")	< 40 µm (< 0.001575")
LRQ600AP-DE51T10A	Non-back-driving	100 N (22.4 lb)	< 75 µm (< 0.002953")	< 60 µm (< 0.002362")
LRQ600BP-DE51T10A	(± 30%) 123 N (27.6 lb)	100 N (22.4 lb)	< 75 µm (< 0.002953")	< 60 µm (< 0.002362")
LRQ600HP-DE51T10A	(± 30%) 123 N (27.6 lb)	200 N (44.9 lb)	< 75 µm (< 0.002953")	< 60 µm (< 0.002362")

Part Number	Pitch	Roll	Yaw	Linear Motion Per Motor Rev
LRQ075AL-DE51T10A	0.025° (0.436 mrad)	0.01° (0.174 mrad)	0.02° (0.349 mrad)	1.27 mm (0.050")
LRQ075BL-DE51T10A	0.025° (0.436 mrad)	0.01° (0.174 mrad)	0.02° (0.349 mrad)	6.35 mm (0.250")
LRQ075HL-DE51T10A	0.025° (0.436 mrad)	0.01° (0.174 mrad)	0.02° (0.349 mrad)	2.5 mm (0.098")
LRQ150AL-DE51T10A	0.03° (0.523 mrad)	0.015° (0.262 mrad)	0.02° (0.349 mrad)	1.27 mm (0.050")
LRQ150BL-DE51T10A	0.03° (0.523 mrad)	0.015° (0.262 mrad)	0.02° (0.349 mrad)	6.35 mm (0.250")
LRQ150HL-DE51T10A	0.03° (0.523 mrad)	0.015° (0.262 mrad)	0.02° (0.349 mrad)	2.5 mm (0.098")
LRQ300AL-DE51T10A	0.034° (0.593 mrad)	0.015° (0.262 mrad)	0.03° (0.523 mrad)	1.27 mm (0.050")
LRQ300BL-DE51T10A	0.034° (0.593 mrad)	0.015° (0.262 mrad)	0.03° (0.523 mrad)	6.35 mm (0.250")
LRQ300HL-DE51T10A	0.034° (0.593 mrad)	0.015° (0.262 mrad)	0.03° (0.523 mrad)	2.5 mm (0.098")
LRQ450AL-DE51T10A	0.04° (0.698 mrad)	0.025° (0.436 mrad)	0.04° (0.698 mrad)	1.27 mm (0.050")

Part Number	Pitch	Roll	Yaw	Linear Motion Per Motor Rev
LRQ450BL-DE51T10A	0.04° (0.698 mrad)	0.025° (0.436 mrad)	0.04° (0.698 mrad)	6.35 mm (0.250")
LRQ450HL-DE51T10A	0.04° (0.698 mrad)	0.025° (0.436 mrad)	0.04° (0.698 mrad)	2.5 mm (0.098")
LRQ600AL-DE51T10A	0.045° (0.785 mrad)	0.035° (0.611 mrad)	0.04° (0.698 mrad)	1.27 mm (0.050")
LRQ600BL-DE51T10A	0.045° (0.785 mrad)	0.035° (0.611 mrad)	0.04° (0.698 mrad)	6.35 mm (0.250")
LRQ600HL-DE51T10A	0.045° (0.785 mrad)	0.035° (0.611 mrad)	0.04° (0.698 mrad)	2.5 mm (0.098")
LRQ075AP-DE51T10A	0.025° (0.436 mrad)	0.01° (0.174 mrad)	0.02° (0.349 mrad)	1.27 mm (0.050")
LRQ075BP-DE51T10A	0.025° (0.436 mrad)	0.01° (0.174 mrad)	0.02° (0.349 mrad)	6.35 mm (0.250")
LRQ075HP-DE51T10A	0.025° (0.436 mrad)	0.01° (0.174 mrad)	0.02° (0.349 mrad)	2.5 mm (0.098")
LRQ150AP-DE51T10A	0.03° (0.523 mrad)	0.015° (0.262 mrad)	0.02° (0.349 mrad)	1.27 mm (0.050")
LRQ150BP-DE51T10A	0.03° (0.523 mrad)	0.015° (0.262 mrad)	0.02° (0.349 mrad)	6.35 mm (0.250")
LRQ150HP-DE51T10A	0.03° (0.523 mrad)	0.015° (0.262 mrad)	0.02° (0.349 mrad)	2.5 mm (0.098")
LRQ300AP-DE51T10A	0.034° (0.593 mrad)	0.015° (0.262 mrad)	0.03° (0.523 mrad)	1.27 mm (0.050")
LRQ300BP-DE51T10A	0.034° (0.593 mrad)	0.015° (0.262 mrad)	0.03° (0.523 mrad)	6.35 mm (0.250")
LRQ300HP-DE51T10A	0.034° (0.593 mrad)	0.015° (0.262 mrad)	0.03° (0.523 mrad)	2.5 mm (0.098")
LRQ450AP-DE51T10A	0.04° (0.698 mrad)	0.025° (0.436 mrad)	0.04° (0.698 mrad)	1.27 mm (0.050")
LRQ450BP-DE51T10A	0.04° (0.698 mrad)	0.025° (0.436 mrad)	0.04° (0.698 mrad)	6.35 mm (0.250")
LRQ450HP-DE51T10A	0.04° (0.698 mrad)	0.025° (0.436 mrad)	0.04° (0.698 mrad)	2.5 mm (0.098")
LRQ600AP-DE51T10A	0.045° (0.785 mrad)	0.035° (0.611 mrad)	0.04° (0.698 mrad)	1.27 mm (0.050")
LRQ600BP-DE51T10A	0.045° (0.785 mrad)	0.035° (0.611 mrad)	0.04° (0.698 mrad)	6.35 mm (0.250")
LRQ600HP-DE51T10A	0.045° (0.785 mrad)	0.035° (0.611 mrad)	0.04° (0.698 mrad)	2.5 mm (0.098")

<b>Part Number</b>	<b>Mechanical Drive System</b>	<b>Weight</b>
LRQ075AL-DE51T10A	Precision lead screw	2.25 kg (4.960 lb)
LRQ075BL-DE51T10A	Precision lead screw	2.25 kg (4.960 lb)
LRQ075HL-DE51T10A	Precision ball screw	2.25 kg (4.960 lb)
LRQ150AL-DE51T10A	Precision lead screw	2.64 kg (5.820 lb)
LRQ150BL-DE51T10A	Precision lead screw	2.64 kg (5.820 lb)
LRQ150HL-DE51T10A	Precision ball screw	2.64 kg (5.820 lb)
LRQ300AL-DE51T10A	Precision lead screw	3.44 kg (7.584 lb)
LRQ300BL-DE51T10A	Precision lead screw	3.44 kg (7.584 lb)
LRQ300HL-DE51T10A	Precision ball screw	3.44 kg (7.584 lb)
LRQ450AL-DE51T10A	Precision lead screw	4.23 kg (9.326 lb)
LRQ450BL-DE51T10A	Precision lead screw	4.23 kg (9.326 lb)
LRQ450HL-DE51T10A	Precision ball screw	4.23 kg (9.326 lb)
LRQ600AL-DE51T10A	Precision lead screw	4.98 kg (10.979 lb)
LRQ600BL-DE51T10A	Precision lead screw	4.98 kg (10.979 lb)
LRQ600HL-DE51T10A	Precision ball screw	4.98 kg (10.979 lb)
LRQ075AP-DE51T10A	Precision lead screw	2.41 kg (5.313 lb)
LRQ075BP-DE51T10A	Precision lead screw	2.41 kg (5.313 lb)
LRQ075HP-DE51T10A	Precision ball screw	2.41 kg (5.313 lb)
LRQ150AP-DE51T10A	Precision lead screw	2.80 kg (6.173 lb)
LRQ150BP-DE51T10A	Precision lead screw	2.80 kg (6.173 lb)
LRQ150HP-DE51T10A	Precision ball screw	2.80 kg (6.173 lb)
LRQ300AP-DE51T10A	Precision lead screw	3.60 kg (7.937 lb)
LRQ300BP-DE51T10A	Precision lead screw	3.60 kg (7.937 lb)
LRQ300HP-DE51T10A	Precision ball screw	3.60 kg (7.937 lb)
LRQ450AP-DE51T10A	Precision lead screw	4.39 kg (9.678 lb)
LRQ450BP-DE51T10A	Precision lead screw	4.39 kg (9.678 lb)
LRQ450HP-DE51T10A	Precision ball screw	4.39 kg (9.678 lb)
LRQ600AP-DE51T10A	Precision lead screw	5.14 kg (11.332 lb)
LRQ600BP-DE51T10A	Precision lead screw	5.14 kg (11.332 lb)
LRQ600HP-DE51T10A	Precision ball screw	5.14 kg (11.332 lb)

LRQ-DE Series Charts

Thrust Speed Performance

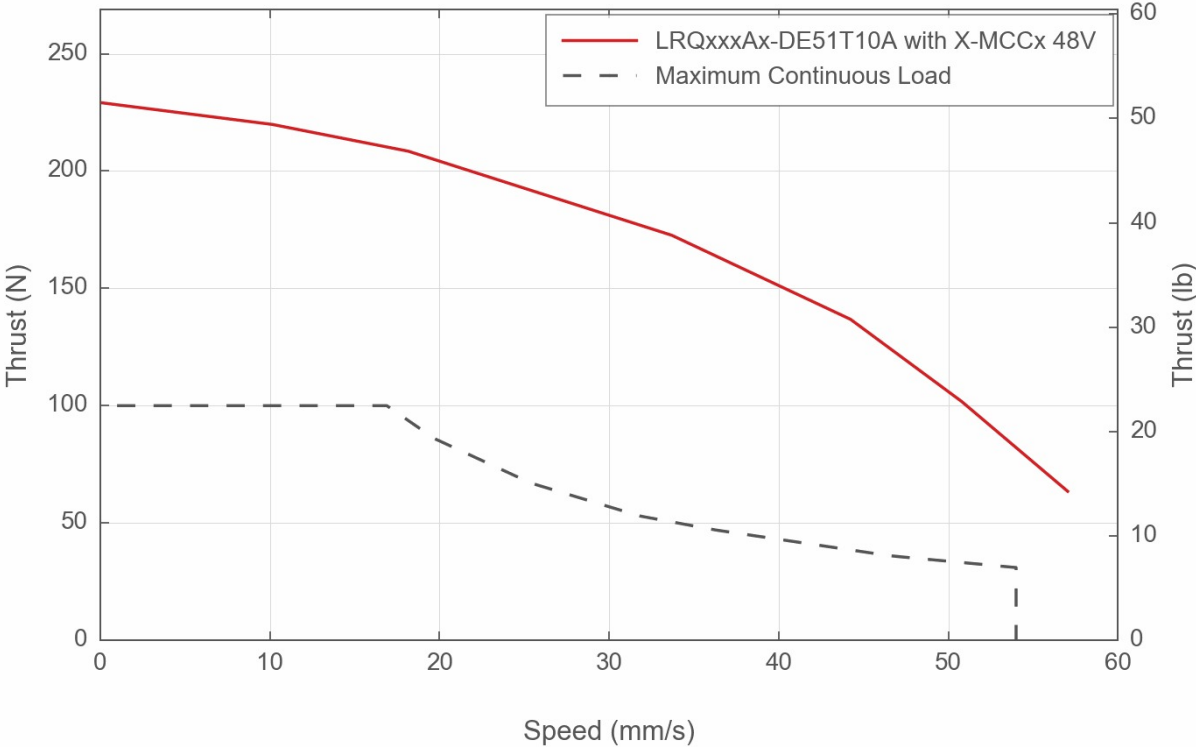

### LRQ Linear Bearing Lifetime

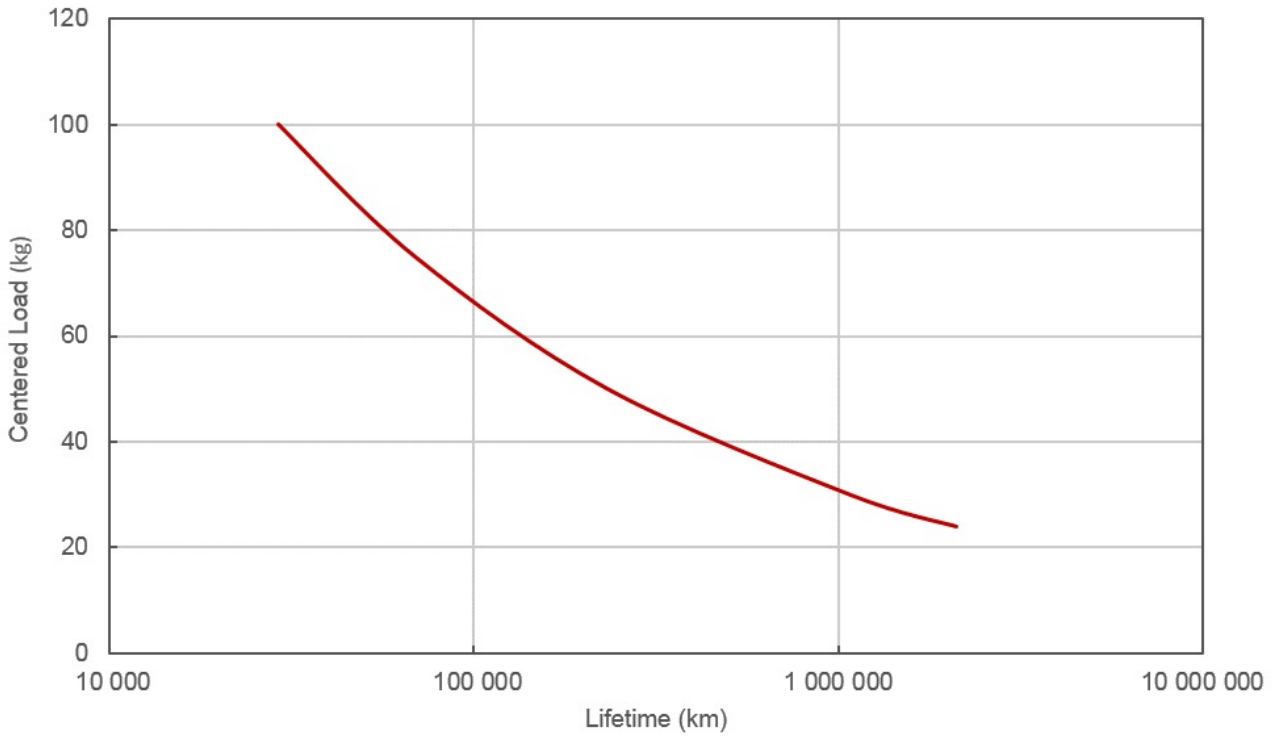

### Typical Accuracy

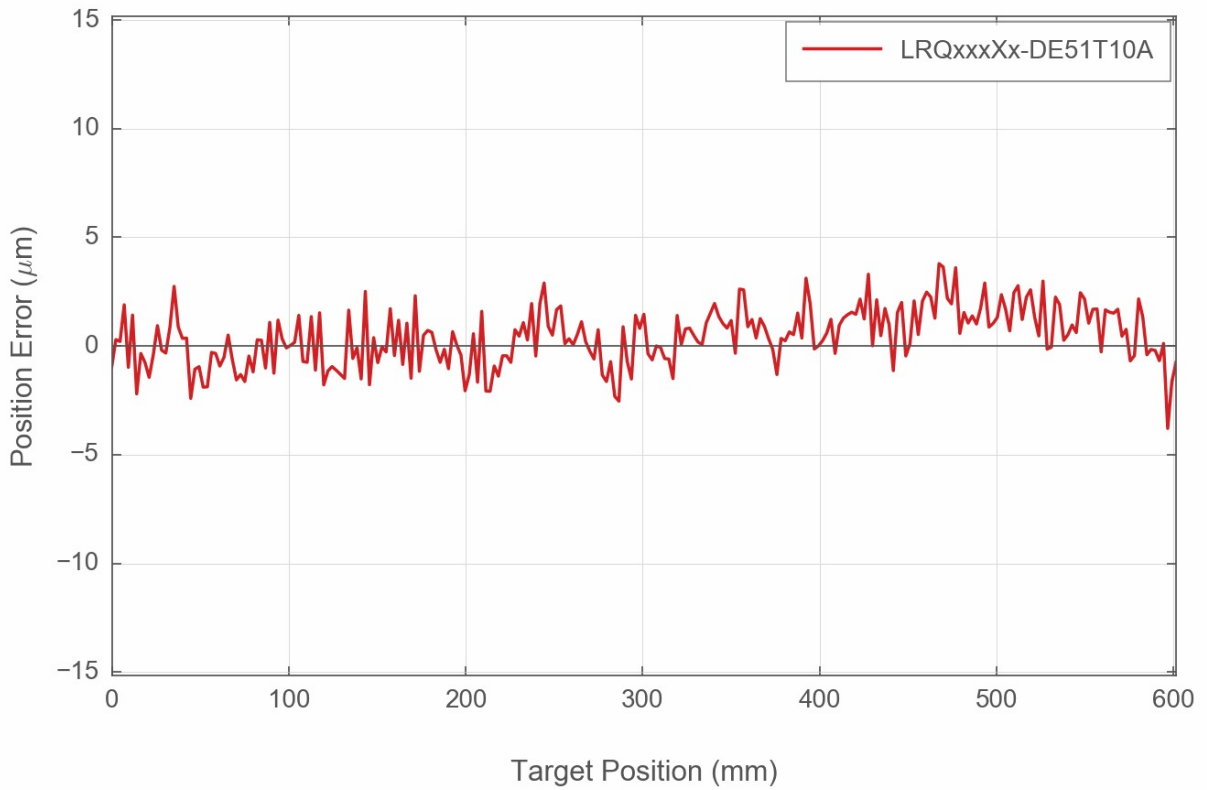

### Thrust Speed Performance

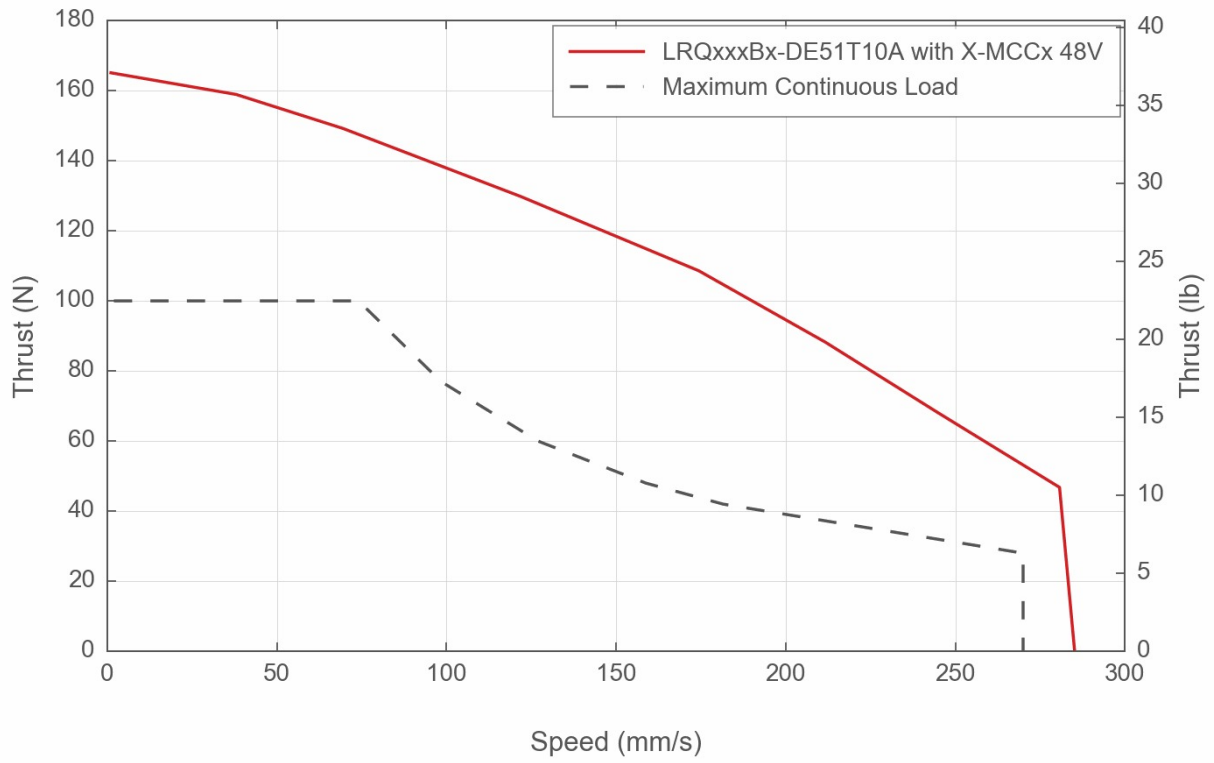

### Thrust Speed Performance

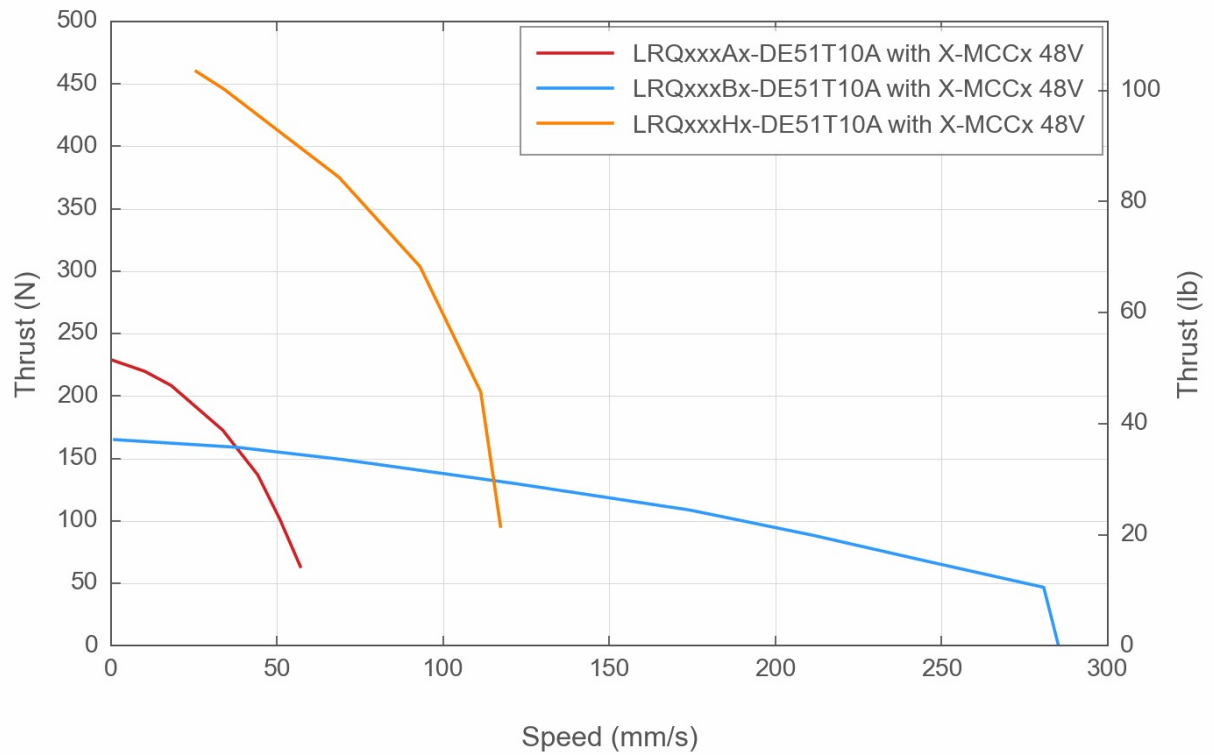

## Thrust Speed Performance

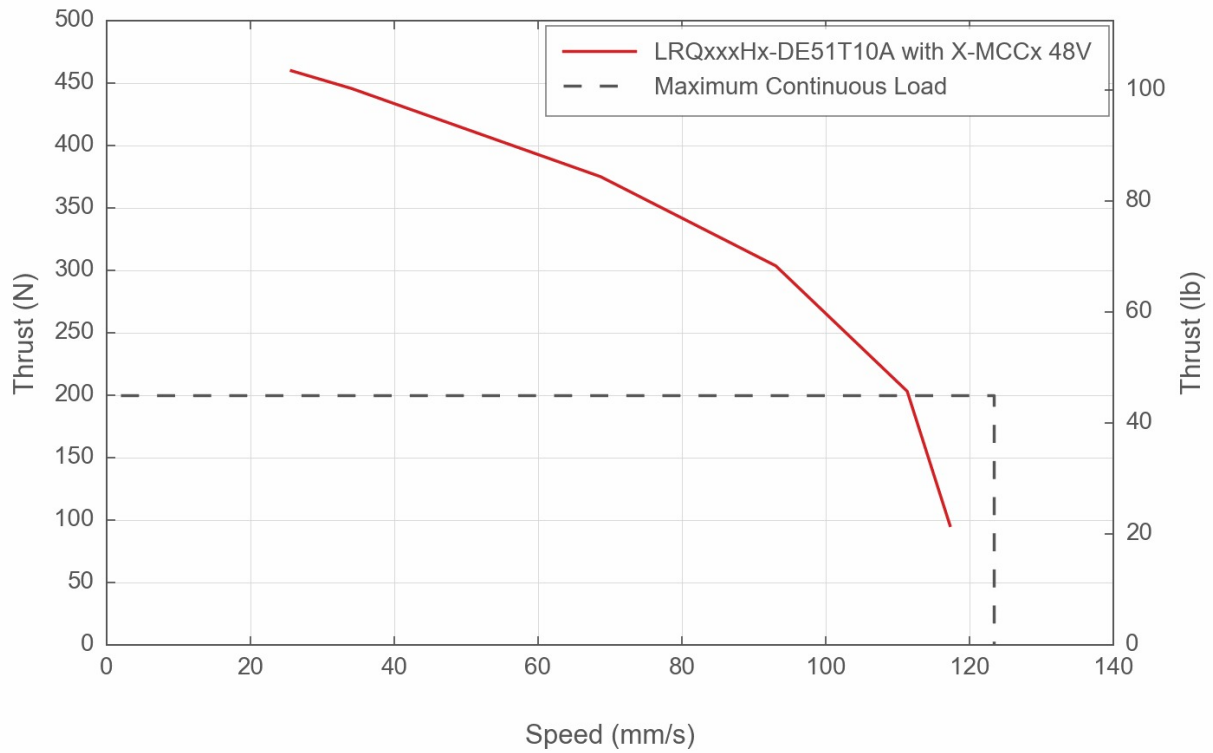

## Contact

Email: [contact@zaber.com](mailto:contact@zaber.com)

Phone (toll free Canada/USA): 1-888-276-8033

Phone (direct): 1-604-569-3780

Fax: 1-604-648-8033

Zaber Technologies Inc.

#2 - 605 West Kent Ave. N.

Vancouver, British Columbia

Canada, V6P 6T7

<https://www.zaber.com>