

LRQ-V2 Series User's Manual

High vacuum motorized linear stages



Disclaimer

Zaber's products are not intended for use in any critical medical, aviation, or military applications or situations where a product's use or failure could cause personal injury, death, or damage to property. Zaber disclaims any warranty of fitness for a particular purpose. The user of this product agrees to [Zaber's general terms and conditions of sale](#).

Precautions

Zaber's motion control devices are precision instruments and must be handled with care. In particular, moving parts must be treated with care. Avoid axial loads in excess of the rated thrust load, axial and radial impact, dust and other contaminants and damage to the leadscrew thread. These will reduce the performance of the device below stated specifications.

Overheating Precautions

The lifetime of the motor and stage will be prolonged by keeping the operating temperatures as low as possible. The motor housing temperature of Zaber's vacuum devices should never exceed 80°C as the longevity of the devices will be compromised.

Monitoring Temperature

There are a few ways to monitor temperature on Zaber devices:

- A and X Series devices have an integrated temperature sensor on their controllers. This may be polled in ASCII using the command [driver.temperature](#) Please see the Quick Command Reference section for more details.
- A K-type thermocouple or other temperature sensor may be mounted to the stage to monitor temperature in order to reduce the risk of overheating. The thermocouple should be attached to the device's motor housing. An example of a proper mounting location is shown below.

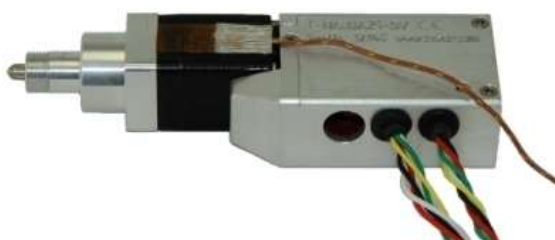

Duty Cycle and Run and Hold Currents

The default run currents on Zaber vacuum devices are set lower than their non-vacuum counterparts however under high duty cycles they may have to be further lowered. Combining low run and hold currents with a reduced duty cycle will often prevent overheating in all but the most extreme of cases.

It is good practice to reduce the hold current as much as is practical for vacuum devices. Positioners with an A pitch leadscrew often do not need a hold current at all to maintain their position. Reducing the hold current is an easy way to reduce the heat generated by your vacuum stage or actuator.

Please contact [Zaber Technical Support](#) to help select the optimal duty cycle and current settings for your positioner.

Vacuum Baking

Vacuum devices can be vacuum baked to reduce pump down time and outgassing. The procedure is to heat the device to its recommended bake-out temperature at a vacuum of less than 10^{-3} Torr for a period of several hours. Allowable bake-out temperature for Zaber's vacuum devices is 80°C.

Do not exceed these temperatures as there are polymer based components in the stage and electrical components in the controller that can be permanently damaged or have their lifetimes significantly shortened by overheating.

Installation

You can mount the LRQ-V stage directly down to an optical breadboard, or to any other surface with M6 x 25 thread spacing. See the [LRQ-V webpage](#) for dimensions, resolution and other details.

LRQ-V stages can be mounted directly in XY using the screws included with the stages. They can be mounted in XYZ using our [AB90M-V](#) angle bracket.

Vacuum Device Mounting Considerations

If possible, vacuum positioners should be mounted to a thermally conductive surface to aid in head dissipation. Preferably, there should be a conductive heat path from the positioner through to the outside of the chamber. If this is not possible, the device should be mounted to a large conductive surface within the chamber. This will help cooling by increasing the rate of radiative heat transfer.

Wiring/Feed-throughs



V1 and V2 vacuum devices are supplied with non-vacuum D-sub15 connectors for ease of testing. The wires must be cut and connected (crimped, screwed, or soldered) to a vacuum feed-through before the device can be operated inside a vacuum chamber. The cut off cable end can be wired to the air-side connector of a vacuum electrical feedthrough to connect directly with a Zaber controller outside of the vacuum chamber.

For the LRQ-V the motor wires are 22 AWG and the hall sensor wires are 28 AWG.

Operation

This unit is designed to be controlled with any of Zaber's X-Series or A-Series [Stepper Motor Controllers](#). Zaber's controllers and peripherals are designed for ease of use when used together. Optimal settings for each peripheral (such as the default current, speed, acceleration, and limit settings) can be loaded by setting the [peripheralid \(T:66\)](#) on the controller. The peripheral ID is listed as the ID on the peripheral's label. A list of IDs is also available on the [ID Mapping](#) page. For more information on device operation, refer to the controller's user manual.

Pinout for D-sub 15 Connectors (A-series and X-Series controllers and peripherals)

A- or X-series controller (female)	
T3 Peripheral (male)	
T4 Peripheral (male)	

Pin #	Function
1	+5V
2	Encoder Error ****

3	<i>reserved</i>
4	Away Sensor ***
5	Home Sensor
6	Ground
7	Motor B1
8	Motor A1
9	+5V *
10	Encoder A *
11	Encoder B *
12	Encoder Index **
13	Ground *
14	Motor B2
15	Motor A2

* *encoder embedded peripherals only*

** *devices with encoders with index only*

*** *devices with away sensors only*

**** *devices with linear or direct-reading encoders only*

Motor

The LRQ-V stage uses a size 17 stepper motor.

- 2.1 A / Phase
- 2.8 mH / phase

- A1 = Red
- A2 = Blue
- B1 = Black
- B2 = Green

Alternate Controllers

The device may be controlled by any 2-phase stepper motor controller with home sensor input. **Warning: Operating the unit without correctly wiring up the home sensor can cause permanent damage to the unit. We do not recommend using your own controller unless you are familiar with how to control a stepper motor with a hall sensor limit switch.** The following information is provided for reference only. Damage to the actuator or hall sensor due to incorrect wiring is not covered by warranty.

Home Sensor Wiring

A Hall effect sensor is mounted in the device for use as a home sensor. It is part number A1122LUA-T made by Allegro. [Click here for data sheet](#). Your controller should be configured so the stage stops immediately (little deceleration) when the home sensor is triggered.

- Wire colour code:
 - 3.6-24 Vdc input - red
 - Home signal - yellow
 - Ground - black

The Hall sensor has an open-collector output. The default output is high impedance when the Hall sensor is not active. When the sensor detects a magnet, the Hall sensor pulls the output low to ground.

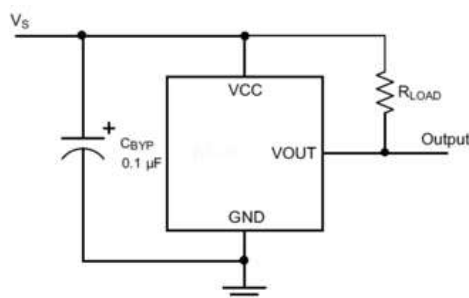

If you are not using a Zaber controller, ensure that your controller has a pull-up resistor on the output line of the Hall sensor as shown in the diagram. The bypass capacitor is optional, but may help to eliminate false triggering in noisy environments. The typical value for the pull-up resistor (R_{LOAD}) is 10k and for the bypass capacitor is 0.1uF to 1uF. The larger the capacitance, the better the noise filtering but the slower the response time.

Warranty and Repair

For Zaber's policies on warranty and repair, please refer to the [Ordering Policies](#).

Standard products

Standard products are any part numbers that do not contain the suffix ENG followed by a 4 digit number. Most, but not all, standard products are listed for sale on our website. All standard Zaber products are backed by a one-month satisfaction guarantee. If you are not satisfied with your purchase, we will refund your payment minus any shipping charges. Goods must be in brand new saleable condition with no marks. Zaber products are guaranteed for one year. During this period Zaber will repair any products with faults due to manufacturing defects, free of charge.

Custom products

Custom products are any part numbers containing the suffix ENG followed by a 4 digit number. Each of these products has been designed for a custom application for a particular customer. Custom products are guaranteed for one year, unless explicitly stated otherwise. During this period Zaber will repair any products with faults due to manufacturing defects, free of charge.

How to return products

Customers with devices in need of return or repair should contact Zaber to obtain an RMA form which must be filled out and sent back to us to receive an RMA number. The RMA form contains instructions for packing and returning the device. The specified RMA number must be included on the shipment to ensure timely processing.

Email Updates

If you would like to receive our periodic email newsletter including product updates and promotions.

Contact Information

Contact Zaber Technologies Inc by any of the following methods:

Phone	1-604-569-3780 (direct) 1-888-276-8033 (toll free in North America)
Fax	1-604-648-8033
Mail	#2 - 605 West Kent Ave. N., Vancouver, British Columbia, Canada, V6P 6T7
Web	www.zaber.com
Email	Please visit our website for up to date email contact information.

The original instructions for this product are available at <https://www.zaber.com/manuals/LRQ-V2>.

Appendix A: Default Settings

Please see [the Zaber Support Page](#) for default settings for this device.

Product Drawing

ZABER

LRQxL-V Vacuum Compatible Motorized Linear Stage
 dimensions in mm

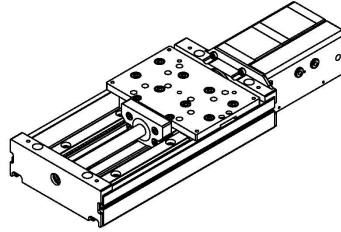

Model Number*	Travel	A	B
LRQ075xL-V	75.0	278.2	167.0
LRQ150xL-V	150.0	353.2	242.0
LRQ300xL-V	300.0	503.2	392.0
LRQ450xL-V	450.0	653.2	542.0
LRQ600xL-V	600.0	803.2	692.0

*See product page for complete list of available models at www.zaber.com

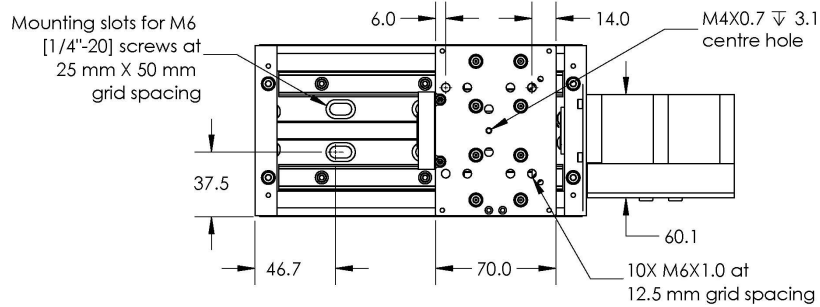

Recommended fastener for side T-slots: standard M2.5 nuts
 Note: Do not mount stage using these side T-slots. For accessories only

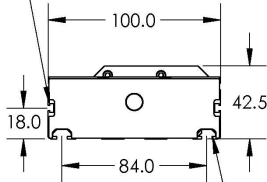

Recommended fastener for bottom T-slots: 6mm T-nuts

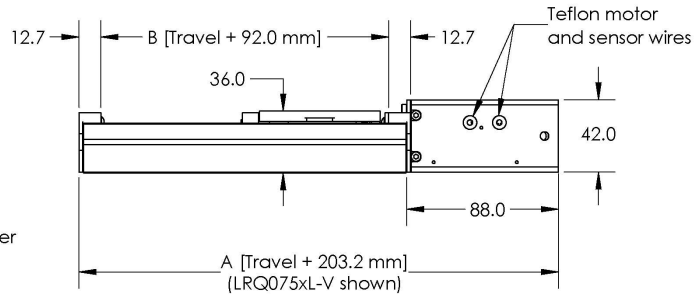

DWG 1926 801

Specifications

Specification	Value	Alternate Unit
Built-in Controller	No	
Recommended Controller	X-MCC (48 V) Recommended	
AutoDetect	No	
Repeatability	< 2.5 μ m	< 0.000098"
Maximum Centered Load	1000 N	224.3 lb
Maximum Moment (Pitch)	30 N·m	22.1 ft·lb
Maximum Moment (Roll)	30 N·m	22.1 ft·lb
Maximum Moment (Yaw)	30 N·m	22.1 ft·lb
Stiffness in Pitch	500 N·m/°	35 μ rad/N·m
Stiffness in Roll	1180 N·m/°	15 μ rad/N·m
Stiffness in Yaw		
Motor Steps Per Rev	200	
Motor Type	Stepper (2 phase)	
Motor Rated Current	2100 mA/phase	
Inductance	2.8 mH/phase	
Motor Connection	Teflon flying leads with D-sub15 connector	
Default Resolution	1/64 of a step	

Specification	Value	Alternate Unit
Guide Type	Recirculating Ball Linear Guide	
Mechanical Drive System	Precision lead screw	
Limit or Home Sensing	Magnetic home sensor	
Manual Control	No	
Axes of Motion	1	
Mounting Interface	M6 and M3 threaded holes	
Operating Temperature Range	0 to 50 °C	
CE Compliant	Yes	
Vacuum Compatible	High vacuum (10 ⁻⁶ Torr)	

Comparison

Part Number	Microstep Size (Default Resolution)	Travel Range	Accuracy (unidirectional)	Backlash
LRQ075AL-V2T4	0.09921875 µm	75 mm (2.953")	23 µm (0.000906")	< 8 µm (< 0.000315")
LRQ075BL-V2T4	0.49609375 µm	75 mm (2.953")	15 µm (0.000591")	< 21 µm (< 0.000827")
LRQ150AL-V2T4	0.09921875 µm	150 mm (5.905")	45 µm (0.001772")	< 8 µm (< 0.000315")
LRQ150BL-V2T4	0.49609375 µm	150 mm (5.905")	25 µm (0.000984")	< 21 µm (< 0.000827")
LRQ300AL-V2T4	0.09921875 µm	300 mm (11.811")	90 µm (0.003543")	< 8 µm (< 0.000315")
LRQ300BL-V2T4	0.49609375 µm	300 mm (11.811")	35 µm (0.001378")	< 21 µm (< 0.000827")
LRQ450AL-V2T4	0.09921875 µm	450 mm (17.716")	135 µm (0.005315")	< 8 µm (< 0.000315")
LRQ450BL-V2T4	0.49609375 µm	450 mm (17.716")	60 µm (0.002362")	< 21 µm (< 0.000827")
LRQ600AL-V2T4	0.09921875 µm	600 mm (23.622")	150 µm (0.005905")	< 8 µm (< 0.000315")
LRQ600BL-V2T4	0.49609375 µm	600 mm (23.622")	90 µm (0.003543")	< 21 µm (< 0.000827")

Part Number	Maximum Speed	Minimum Speed	Speed Resolution	Peak Thrust
LRQ075AL-V2T4	35 mm/s (1.378"/s)	0.000061 mm/s (0.000002"/s)	0.000061 mm/s (0.000002"/s)	100 N (22.4 lb)
LRQ075BL-V2T4	205 mm/s (8.071"/s)	0.000303 mm/s (0.000012"/s)	0.000303 mm/s (0.000012"/s)	60 N (13.5 lb)
LRQ150AL-V2T4	35 mm/s (1.378"/s)	0.000061 mm/s (0.000002"/s)	0.000061 mm/s (0.000002"/s)	100 N (22.4 lb)
LRQ150BL-V2T4	205 mm/s (8.071"/s)	0.000303 mm/s (0.000012"/s)	0.000303 mm/s (0.000012"/s)	60 N (13.5 lb)
LRQ300AL-V2T4	35 mm/s (1.378"/s)	0.000061 mm/s (0.000002"/s)	0.000061 mm/s (0.000002"/s)	100 N (22.4 lb)
LRQ300BL-V2T4	205 mm/s (8.071"/s)	0.000303 mm/s (0.000012"/s)	0.000303 mm/s (0.000012"/s)	60 N (13.5 lb)
LRQ450AL-V2T4	35 mm/s (1.378"/s)	0.000061 mm/s (0.000002"/s)	0.000061 mm/s (0.000002"/s)	100 N (22.4 lb)
LRQ450BL-V2T4	205 mm/s (8.071"/s)	0.000303 mm/s (0.000012"/s)	0.000303 mm/s (0.000012"/s)	60 N (13.5 lb)
LRQ600AL-V2T4	35 mm/s (1.378"/s)	0.000061 mm/s (0.000002"/s)	0.000061 mm/s (0.000002"/s)	100 N (22.4 lb)
LRQ600BL-V2T4	205 mm/s (8.071"/s)	0.000303 mm/s (0.000012"/s)	0.000303 mm/s (0.000012"/s)	60 N (13.5 lb)

Part Number	Maximum Continuous Thrust	Vertical Runout	Horizontal Runout	Pitch
LRQ075AL-V2T4	100 N (22.4 lb)	< 20 μm (< 0.000787")	< 20 μm (< 0.000787")	0.025° (0.436 mrad)
LRQ075BL-V2T4	60 N (13.5 lb)	< 20 μm (< 0.000787")	< 20 μm (< 0.000787")	0.025° (0.436 mrad)
LRQ150AL-V2T4	100 N (22.4 lb)	< 25 μm (< 0.000984")	< 20 μm (< 0.000787")	0.03° (0.523 mrad)
LRQ150BL-V2T4	60 N (13.5 lb)	< 25 μm (< 0.000984")	< 20 μm (< 0.000787")	0.03° (0.523 mrad)
LRQ300AL-V2T4	100 N (22.4 lb)	< 35 μm (< 0.001378")	< 30 μm (< 0.001181")	0.034° (0.593 mrad)
LRQ300BL-V2T4	60 N (13.5 lb)	< 35 μm (< 0.001378")	< 30 μm (< 0.001181")	0.034° (0.593 mrad)
LRQ450AL-V2T4	100 N (22.4 lb)	< 45 μm (< 0.001772")	< 40 μm (< 0.001575")	0.04° (0.698 mrad)
LRQ450BL-V2T4	60 N (13.5 lb)	< 45 μm (< 0.001772")	< 40 μm (< 0.001575")	0.04° (0.698 mrad)
LRQ600AL-V2T4	100 N (22.4 lb)	< 75 μm (< 0.002953")	< 60 μm (< 0.002362")	0.045° (0.785 mrad)
LRQ600BL-V2T4	60 N (13.5 lb)	< 75 μm (< 0.002953")	< 60 μm (< 0.002362")	0.045° (0.785 mrad)

Part Number	Roll	Yaw	Linear Motion Per Motor Rev	Weight
LRQ075AL-V2T4	0.01° (0.174 mrad)	0.02° (0.349 mrad)	1.27 mm (0.050")	2.27 kg (5.004 lb)
LRQ075BL-V2T4	0.01° (0.174 mrad)	0.02° (0.349 mrad)	6.35 mm (0.250")	2.27 kg (5.004 lb)
LRQ150AL-V2T4	0.015° (0.262 mrad)	0.02° (0.349 mrad)	1.27 mm (0.050")	2.64 kg (5.820 lb)
LRQ150BL-V2T4	0.015° (0.262 mrad)	0.02° (0.349 mrad)	6.35 mm (0.250")	2.64 kg (5.820 lb)
LRQ300AL-V2T4	0.015° (0.262 mrad)	0.03° (0.523 mrad)	1.27 mm (0.050")	3.4 kg (7.496 lb)
LRQ300BL-V2T4	0.015° (0.262 mrad)	0.03° (0.523 mrad)	6.35 mm (0.250")	3.4 kg (7.496 lb)
LRQ450AL-V2T4	0.025° (0.436 mrad)	0.04° (0.698 mrad)	1.27 mm (0.050")	4.15 kg (9.149 lb)
LRQ450BL-V2T4	0.025° (0.436 mrad)	0.04° (0.698 mrad)	6.35 mm (0.250")	4.15 kg (9.149 lb)
LRQ600AL-V2T4	0.035° (0.611 mrad)	0.04° (0.698 mrad)	1.27 mm (0.050")	4.86 kg (10.714 lb)
LRQ600BL-V2T4	0.035° (0.611 mrad)	0.04° (0.698 mrad)	6.35 mm (0.250")	4.86 kg (10.714 lb)

Thrust Speed Performance

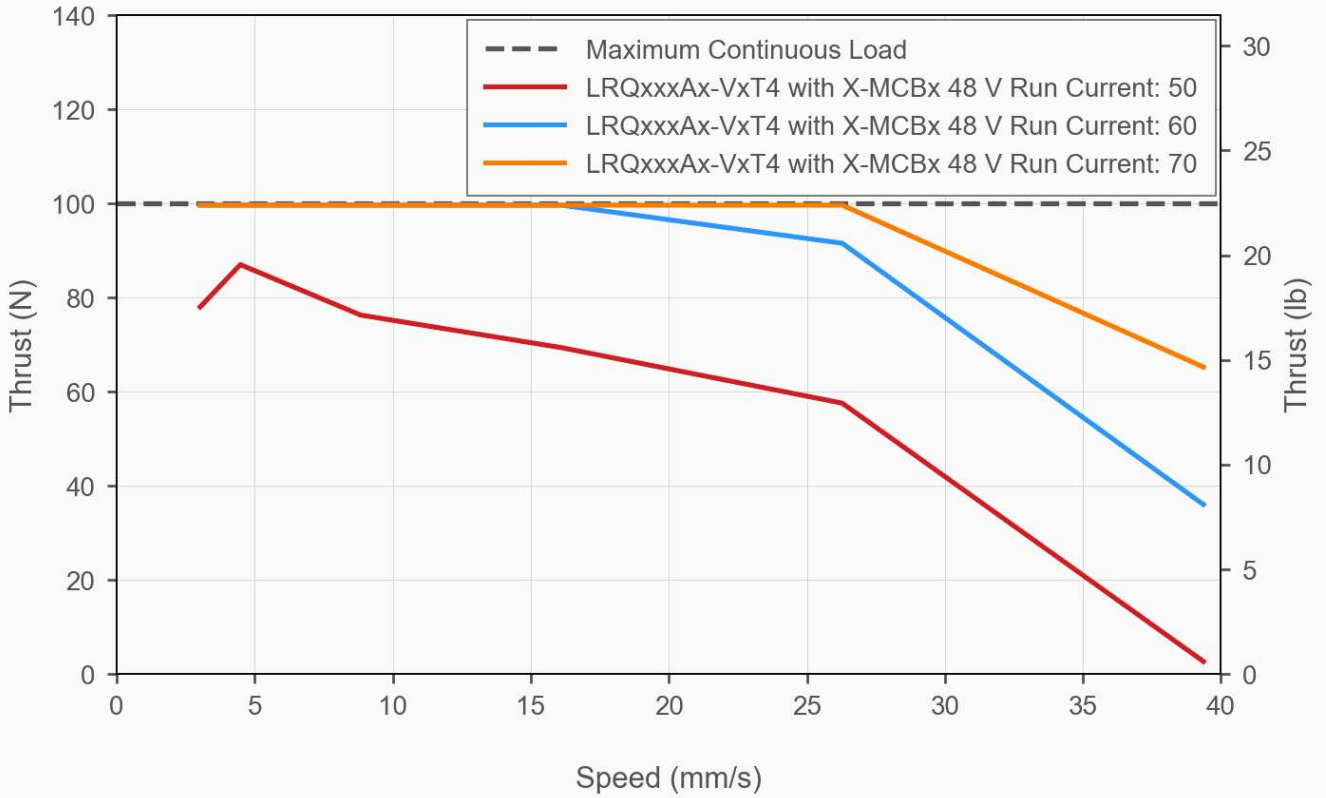

Thrust Speed Performance

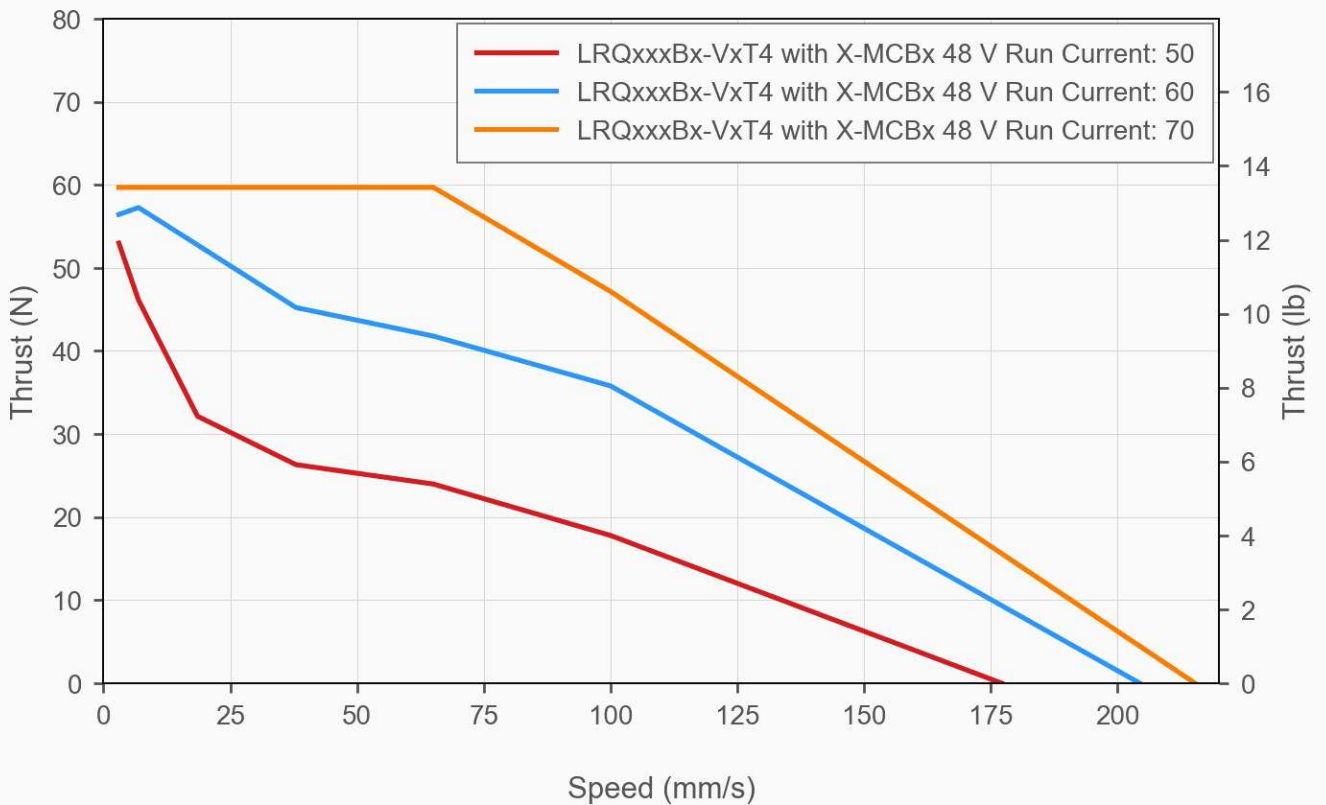

Recommended Duty Cycle

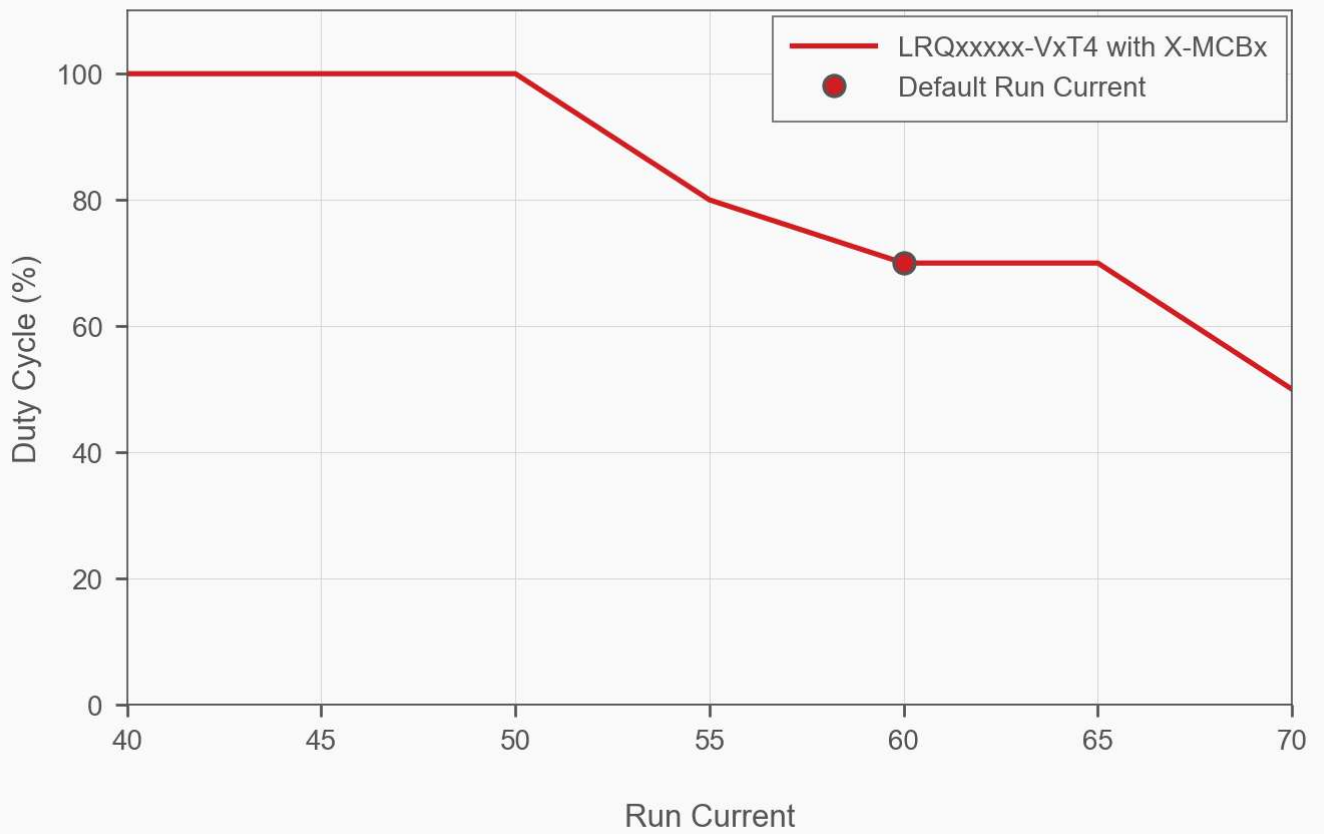

LRQ Linear Bearing Lifetime

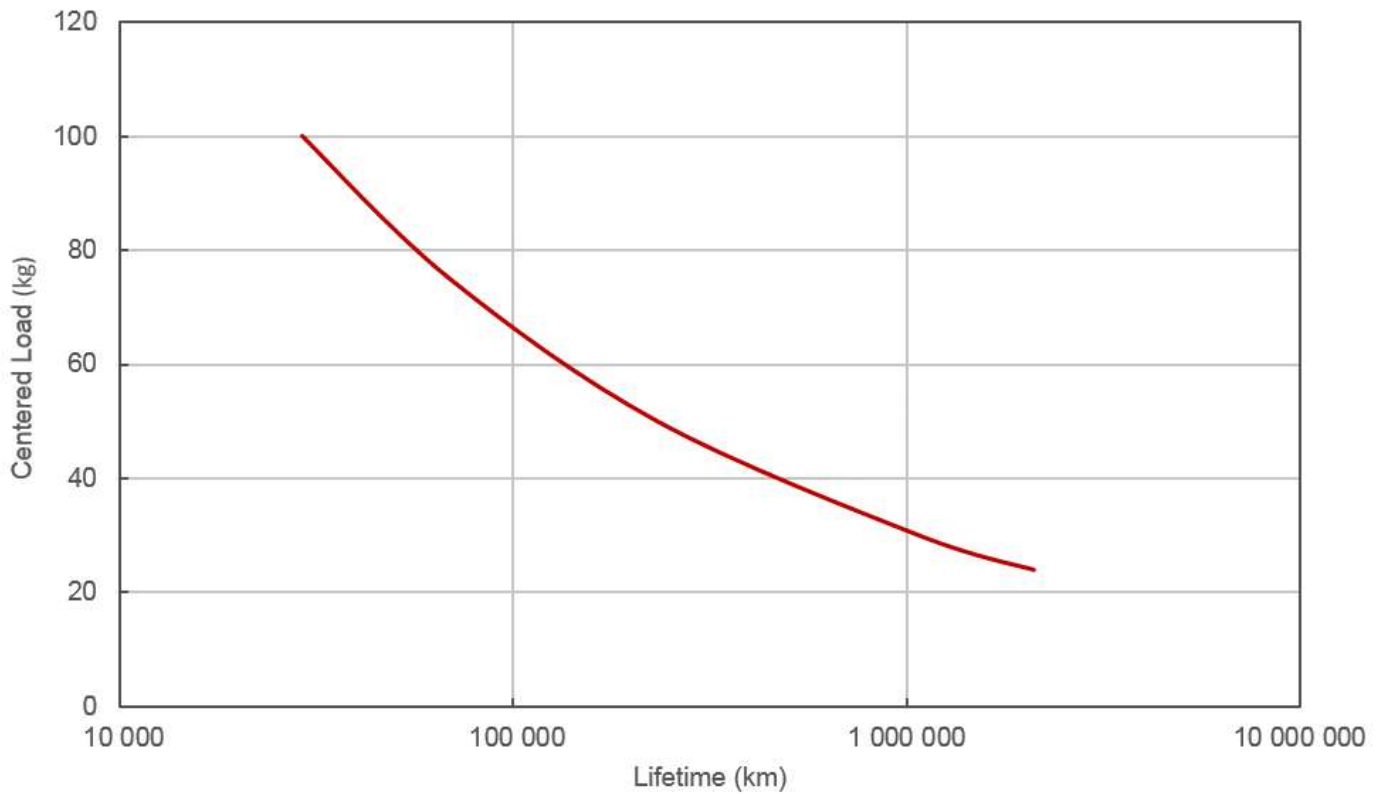

Product Change Notices

Click [here](#) to view the current product change notices and subscribe to future change notifications.