

LRQ300HP-E01T3A Datasheet



- 75, 150, 300, 450, 600 mm travel
- Up to 840 mm/s speed and up to 500 N thrust
- 100 kg load capacity
- Inline and parallel drive configurations
- Encoder position feedback with slip/stall detection and automatic recovery
- Ball screw and lead screw configurations
- Designed for use with an X-MCC Series stepper motor controller or any 2-phase stepper motor controller
- With AutoDetect, the X-MCC controller configures its settings automatically for the connected peripheral
- Custom versions available

LRQ-E Series Overview

Zaber's LRQ-E Series products are computer-controlled, motorized linear stages with high stiffness, load, and lifetime capabilities in a compact size. At only 36 mm high, these stages are excellent for applications where a low profile is required. These stages are capable of speeds up to 840 mm/s, and can bolt together into XY and XYZ systems. Some multi axis configurations may require additional accessories, please contact Zaber Technical Support to ensure the correct ones are selected. Each device is available in either an inline or parallel drive configuration. The built-in motor encoder allows for closed-loop operation and slip/stall recovery features.

The stages are designed to connect directly to our X-MCC Series universal motor controllers, or they can be used with any 2-phase stepper motor controller through the panel mount DB15 connector. Set up is easy with AutoDetect. Once connected, the X-MCC controller will automatically detect and configure the LRQ-E.

For more information visit: <https://www.zaber.com/products/linear-stages/LRQ-E>

LRQ-E Series Part Numbering & Options

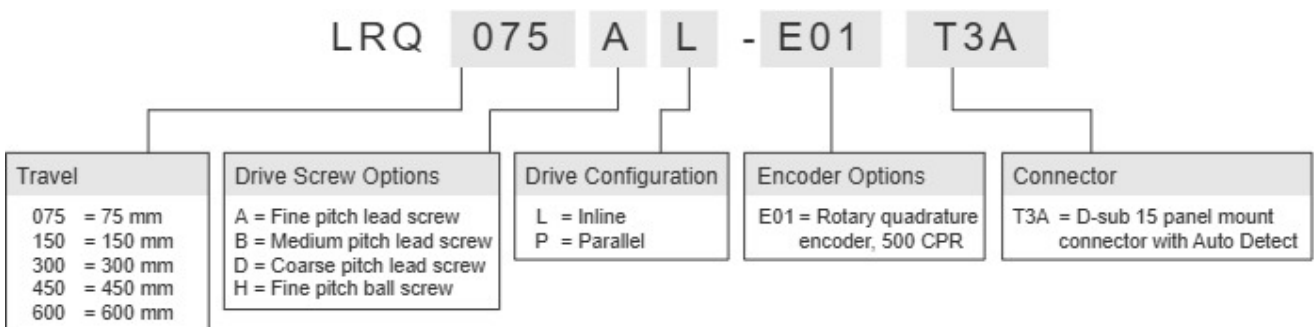

LRQ300HP-E01T3A Drawings

- [LRQxP-E.png \(Dimension Drawing for the LRQxP-E\)](#)

LRQ300HP-E01T3A Specifications

Microstep Size (Default Resolution)	0.1953125 μm
Built-in Controller	No
Recommended Controller	X-MCC (48 V) Recommended
AutoDetect	Yes
Travel Range	300 mm (11.811")
Accuracy (unidirectional)	65 μm (0.002559")
Repeatability	< 5 μm (< 0.000197")
Backlash	< 30 μm (< 0.001181")
Maximum Speed	110 mm/s (4.331"/s)
Minimum Speed	0.000119 mm/s (0.000005"/s)
Speed Resolution	0.000119 mm/s (0.000005"/s)
Encoder Resolution	500 CPR (2000 states/rev)
Encoder Type	Rotary quadrature encoder
Peak Thrust	500 N (112.1 lb)
Back-driving Force*	(\pm 30%) 123 N (27.6 lb)
Maximum Continuous Thrust	200 N (44.9 lb)
Maximum Centered Load	1000 N (224.3 lb)
Maximum Moment (Pitch)	30 N-m (22.1 ft-lb)
Maximum Moment (Roll)	30 N-m (22.1 ft-lb)
Maximum Moment (Yaw)	30 N-m (22.1 ft-lb)
Vertical Runout	< 35 μm (< 0.001378")
Horizontal Runout	< 30 μm (< 0.001181")
Pitch	0.034° (0.593 mrad)
Roll	0.015° (0.262 mrad)
Yaw	0.03° (0.523 mrad)
Stiffness in Pitch	500 N-m/° (35 $\mu\text{rad/N-m}$)
Stiffness in Roll	1180 N-m/° (15 $\mu\text{rad/N-m}$)
Stiffness in Yaw	450 N-m/° (39 $\mu\text{rad/N-m}$)
Linear Motion Per Motor Rev	2.5 mm (0.098")
Motor Steps Per Rev	200
Motor Type	Stepper (2 phase)

Microstep Size (Default Resolution)	0.1953125 μm
Motor Rated Current	2300 mA/phase
Motor Winding Resistance	1 ohms/phase
Inductance	2.2 mH/phase
Motor Connection	D-sub 15
Default Resolution	1/64 of a step
Guide Type	Recirculating Ball Linear Guide
Mechanical Drive System	Precision ball screw
Limit or Home Sensing	Magnetic home sensor
Axes of Motion	1
Mounting Interface	M6 and M3 threaded holes
Operating Temperature Range	0 to 50 °C
CE Compliant	Yes
Vacuum Compatible	No
Weight	3.42 kg (7.540 lb)

LRQ-E Series Charts

Thrust Speed Performance

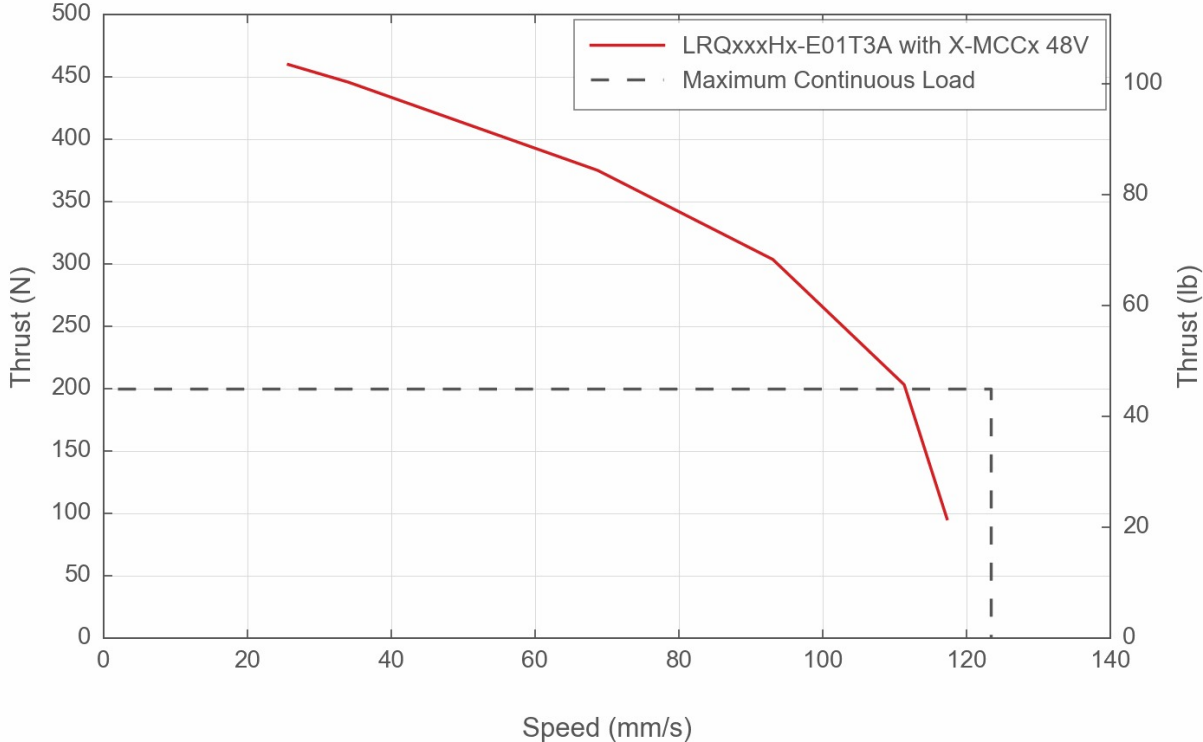

Thrust Speed Performance



Thrust Speed Performance



Thrust Speed Performance

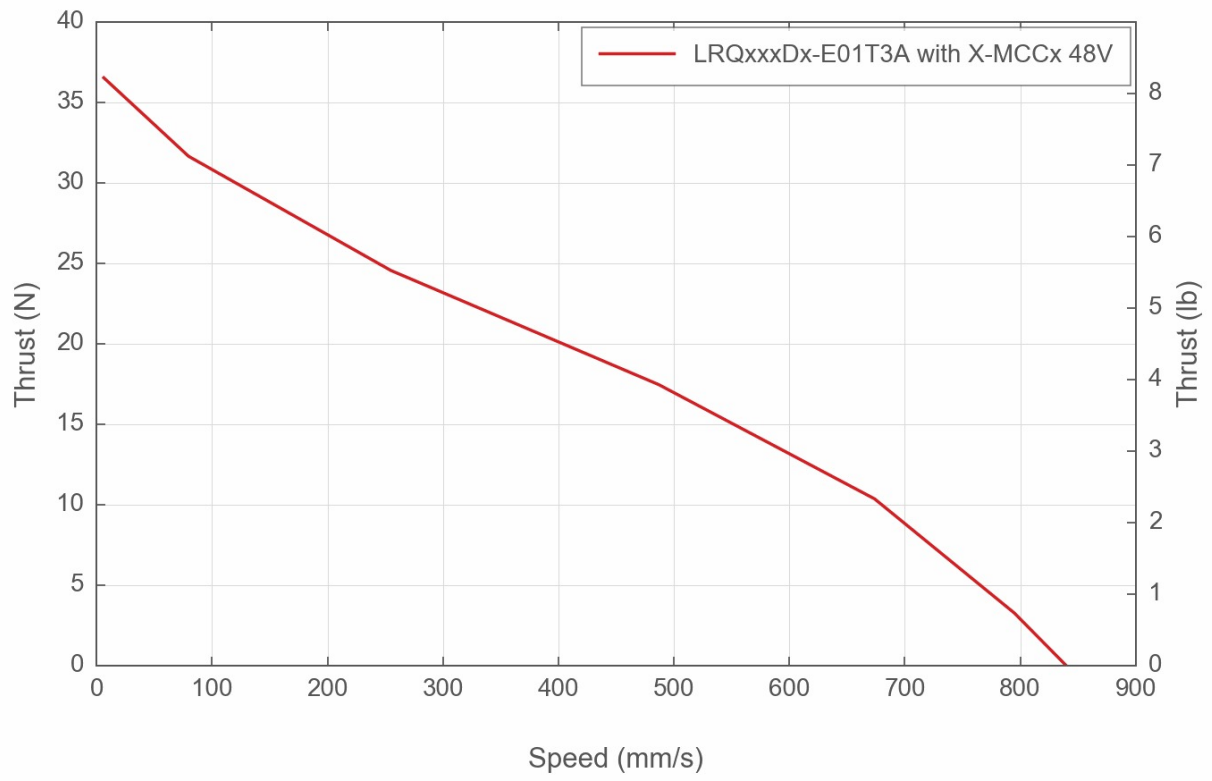

Thrust Speed Performance



LRQ Linear Bearing Lifetime



Contact

Email: contact@zaber.com

Phone (toll free Canada/USA): 1-888-276-8033

Phone (direct): 1-604-569-3780

Fax: 1-604-648-8033

Zaber Technologies Inc.

#2 - 605 West Kent Ave. N.

Vancouver, British Columbia

Canada, V6P 6T7

<https://www.zaber.com>