

X-LRQ075AL-SV2 Datasheet



- Vacuum compatible to 10⁻⁶ Torr
- 75, 150, 300, 450, 600 mm travel
- Up to 205 mm/s speed and up to 100 N thrust
- 100 kg load capacity
- Built-in controller; daisy-chains with other Zaber products
- Only 4 feedthrough wires required to control all units in the daisy-chain via serial port (with an X-PIB adaptor)
- Custom versions available

X-LRQ-SV2 Series Overview

For more information about the basics of a vacuum system and considerations to keep in mind when gathering requirements for your application, read our technical article, "Motion Device Design Considerations for Vacuum Applications".

Zaber's X-LRQ-SV2 Series devices are high-vacuum, computer-controlled, motorized linear stages with high stiffness, load, and lifetime capabilities in a compact size. They are stand-alone units requiring only a standard 24 V or 48 V power supply.

These stages connect to the RS-232 port or USB port of any computer, and they can be daisy-chained with any other Zaber products. The daisy-chain also shares power, making it possible for multiple X-Series products to share a single power supply.

At only 36 mm high, these vacuum stages are excellent for applications where a low profile is required. The X-LRQ-SV2's innovative design allows speeds up to 205 mm/s and loads up to 100 kg. Like all of Zaber's products, the X-LRQ-SV2 Series is designed to be 'plug and play' and very easy to set up and operate. These stages can bolt together into an XY system.

For more information visit: <https://www.zaber.com/products/vacuum-compatible-stages/X-LRQ-SV2>

X-LRQ-SV2 Series Part Numbering & Options

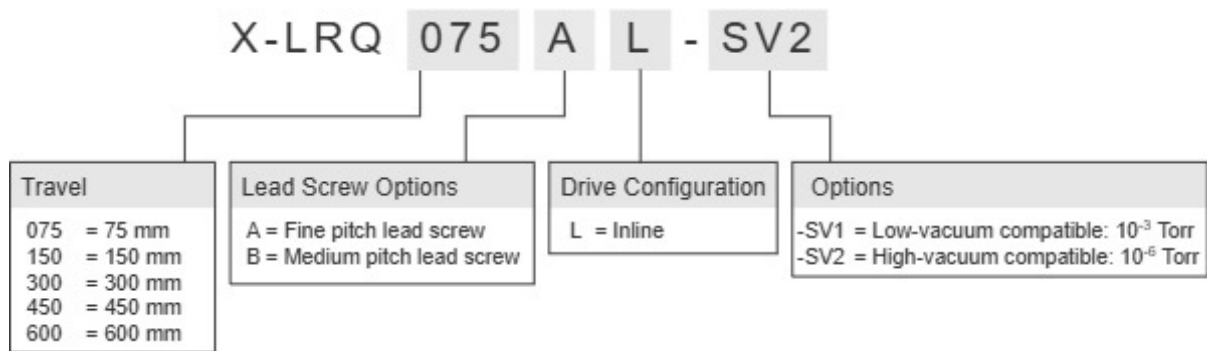

X-LRQ075AL-SV2 Drawings

- [X-LRQxL-SV.png \(Dimension Drawing for the X-LRQxL-SV\)](#)

X-LRQ075AL-SV2 Specifications

Microstep Size (Default Resolution)	0.09921875 μm
Built-in Controller	Yes
Travel Range	75 mm (2.953")
Accuracy (unidirectional)	23 μm (0.000906")
Repeatability	< 2.5 μm (< 0.000098")
Backlash	< 8 μm (< 0.000315")
Maximum Speed	35 mm/s (1.378"/s)
Minimum Speed	0.000061 mm/s (0.000002"/s)
Speed Resolution	0.000061 mm/s (0.000002"/s)
Peak Thrust	100 N (22.4 lb)
Maximum Continuous Thrust	100 N (22.4 lb)
Communication Interface	RS-232
Communication Protocol	Zaber ASCII (Default), Zaber Binary
Data Cable Connection	Teflon flying leads with M8 4 pin M/F
Maximum Centered Load	1000 N (224.3 lb)
Maximum Moment (Pitch)	30 N-m (22.1 ft-lb)
Maximum Moment (Roll)	30 N-m (22.1 ft-lb)
Maximum Moment (Yaw)	30 N-m (22.1 ft-lb)
Vertical Runout	< 20 μm (< 0.000787")
Horizontal Runout	< 20 μm (< 0.000787")
Pitch	0.025° (0.436 mrad)
Roll	0.01° (0.174 mrad)
Yaw	0.02° (0.349 mrad)
Stiffness in Pitch	500 N-m/° (35 $\mu\text{rad/N-m}$)
Stiffness in Roll	1180 N-m/° (15 $\mu\text{rad/N-m}$)
Stiffness in Yaw	450 N-m/° (39 $\mu\text{rad/N-m}$)
Power Supply	24-48 VDC
Power Plug	None, use X-PIB
Maximum Current Draw	1900 mA
Linear Motion Per Motor Rev	1.27 mm (0.050")
Motor Steps Per Rev	200

Microstep Size (Default Resolution)	0.09921875 μm
Motor Type	Stepper (2 phase)
Motor Rated Current	2100 mA/phase
Inductance	2.8 mH/phase
Default Resolution	1/64 of a step
Guide Type	Recirculating Ball Linear Guide
Mechanical Drive System	Precision lead screw
Limit or Home Sensing	Magnetic home sensor
Manual Control	No
Axes of Motion	1
LED Indicators	Yes
Mounting Interface	M6 and M3 threaded holes
Operating Temperature Range	0 to 50 °C
CE Compliant	Yes
Vacuum Compatible	High vacuum (10 ⁻⁶ Torr)
Weight	2.27 kg (5.004 lb)

X-LRQ-SV2 Series Charts

Thrust Speed Performance

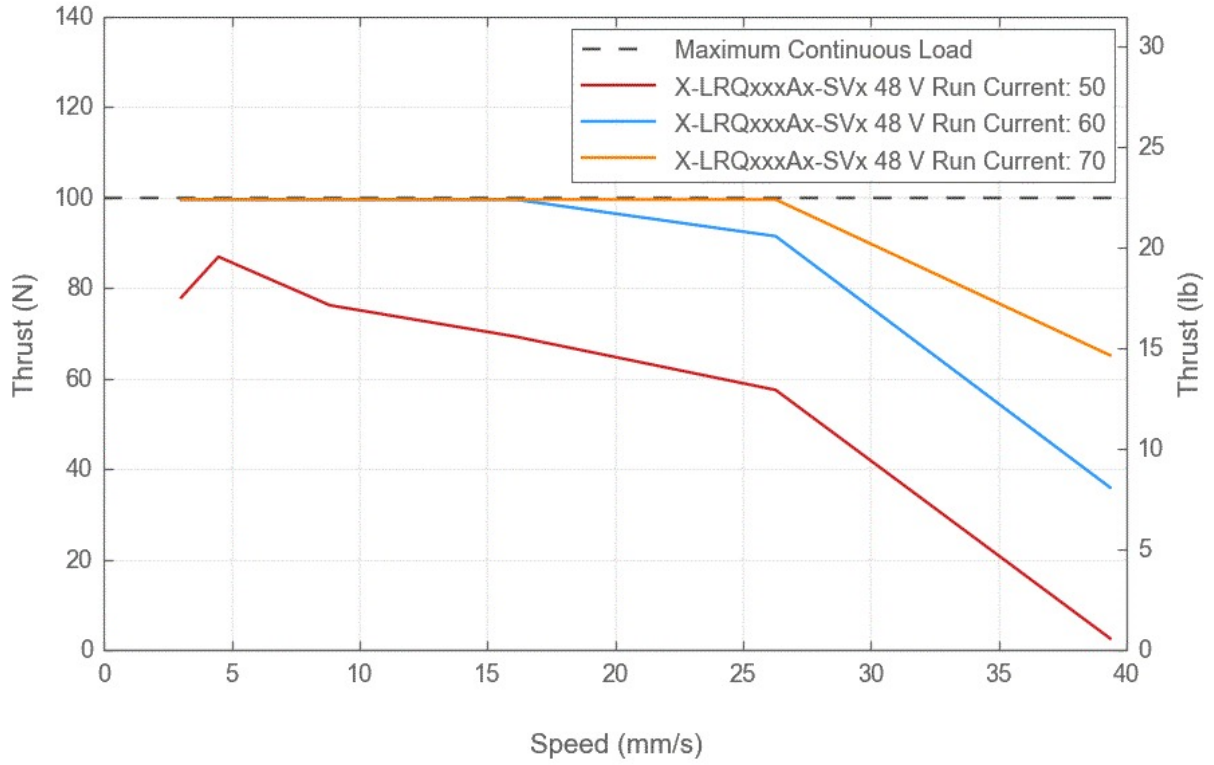

Thrust Speed Performance

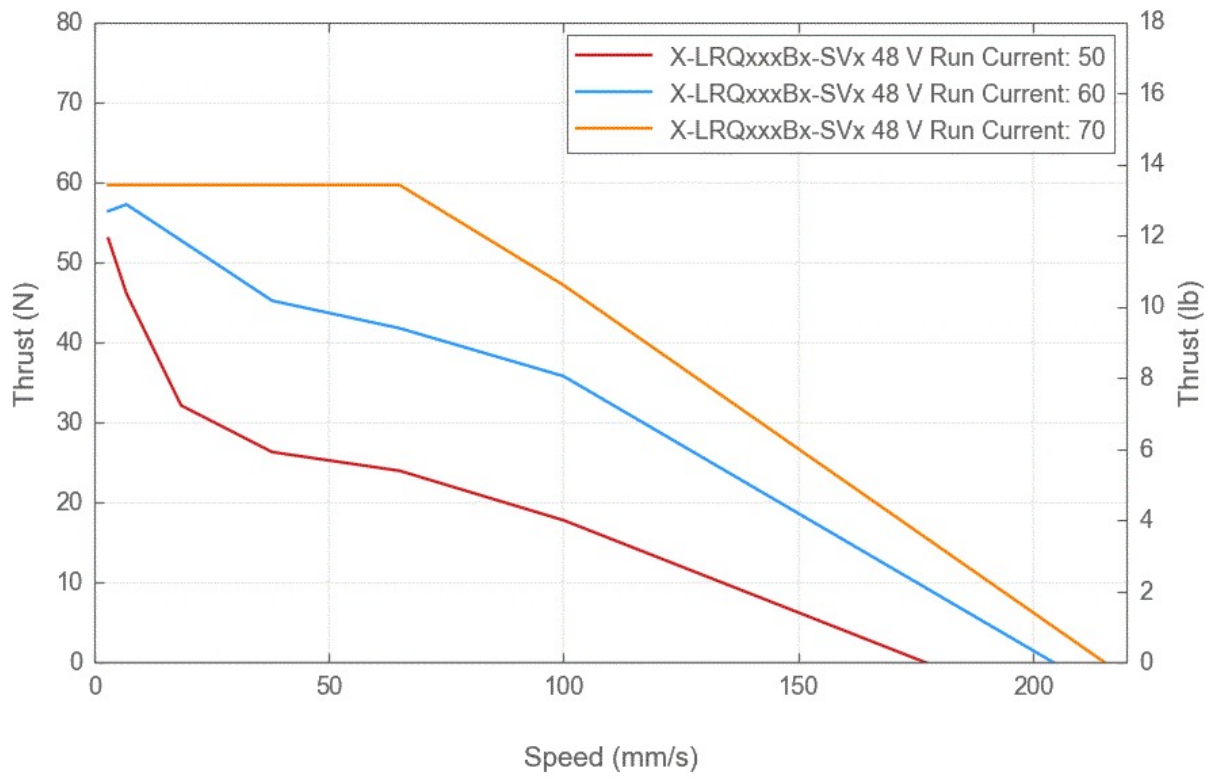

Recommended Duty Cycle

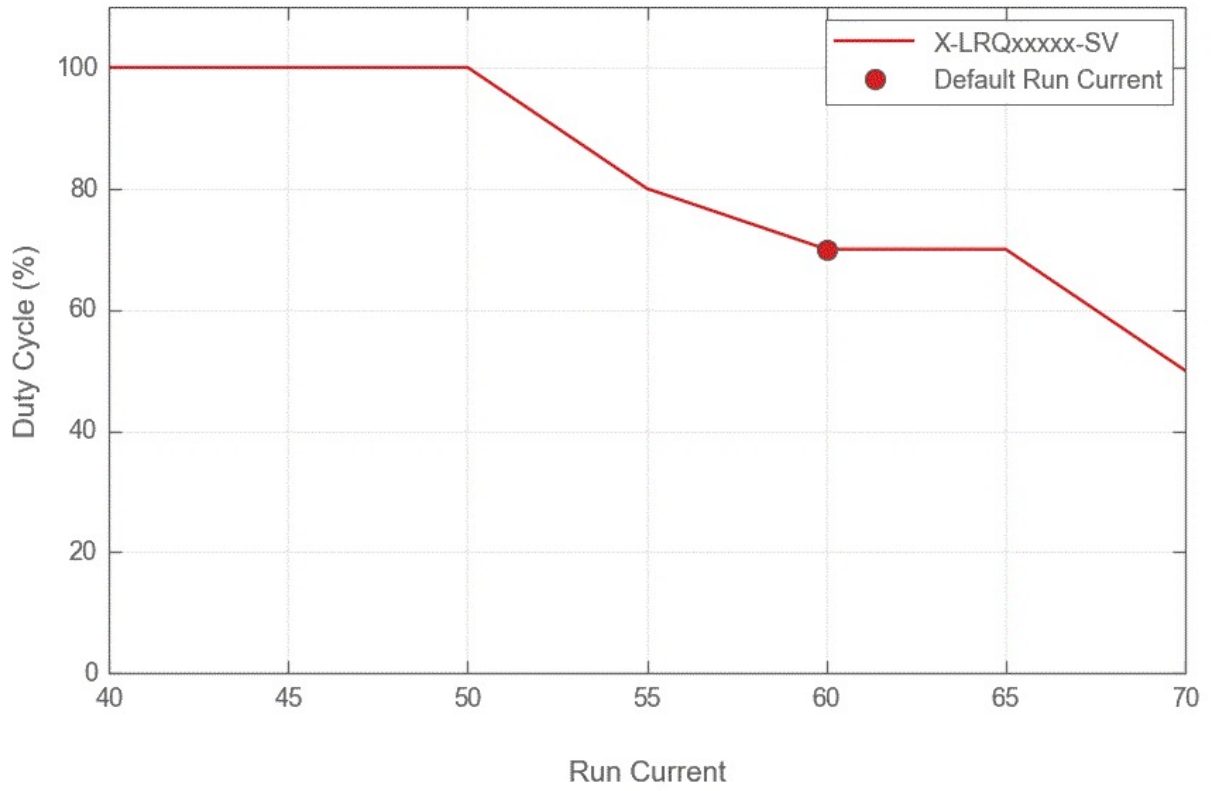

LRQ Linear Bearing Lifetime



Contact

Email: contact@zaber.com

Phone (toll free Canada/USA): 1-888-276-8033

Phone (direct): 1-604-569-3780

Fax: 1-604-648-8033

Zaber Technologies Inc.

#2 - 605 West Kent Ave. N.

Vancouver, British Columbia

Canada, V6P 6T7

<https://www.zaber.com>