

X-LRQ075DL-E01C Datasheet



- 75, 150, 300, 450, 600 mm travel
- Up to 840 mm/s speed and up to 300 N thrust
- 100 kg load capacity
- Inline and parallel drive configurations
- Ball screw and lead screw configurations
- Includes stainless steel dust cover
- Integrated, 500 CPR, motor mounted encoder provides slip/stall detection and recovery
- Built-in controller; daisy-chains with other Zaber products
- Custom versions available

X-LRQ-EC Series Overview

Zaber's X-LRQ-EC Series devices are computer-controlled, motorized linear stages with high stiffness, load, and lifetime capabilities in a compact size. Each device is available in either an inline or parallel drive configuration. A flexible stainless steel dust cover prevents the ingress of small objects. They are stand-alone units requiring only a standard 24 V or 48 V power supply. The built-in motor encoder allows closed-loop operation and slip/stall recovery features. An optional indexed knob provides convenient manual control for versatile operation even without a computer.

These stages connect to the RS-232 port or USB port of any computer, and they can be daisy-chained with any other Zaber products. The daisy-chain also shares power, making it possible for multiple X-Series products to share a single power supply. Convenient locking, 4-pin, M8 connectors on the unit allow for secure connection between units.

At only 48 mm high, these stages are excellent for applications where a low profile is required. The X-LRQ-EC's innovative design allows speeds up to 840 mm/s and loads up to 100 kg. Like all of Zaber's products, the X-LRQ-EC Series is designed to be 'plug and play' and very easy to set up and operate. These stages can bolt together into XY and XYZ systems. Some multi axis configurations may require additional accessories, please contact Zaber Technical Support to ensure the correct ones are selected.

For more information visit: <https://www.zaber.com/products/linear-stages/X-LRQ-EC>

X-LRQ-EC Series Part Numbering & Options

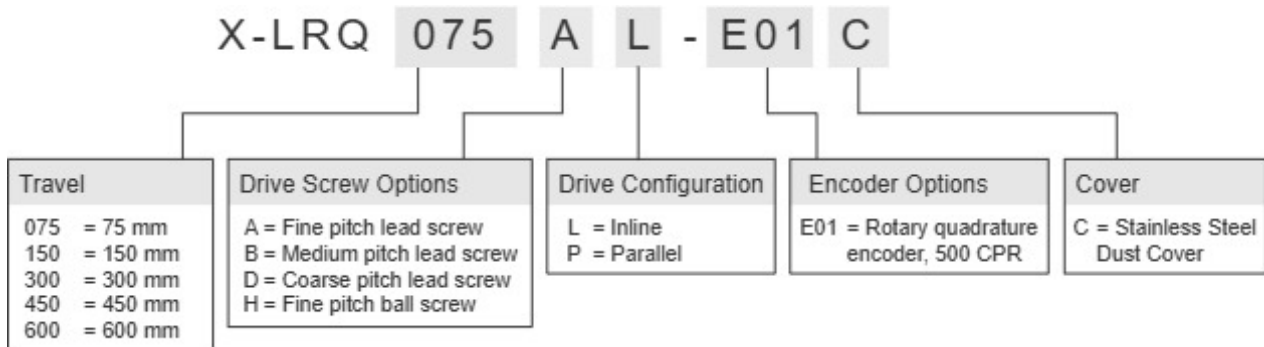

X-LRQ075DL-E01C Drawings

- [X-LRQxL-EC.png \(Dimension Drawing for the X-LRQxL-EC\)](#)

X-LRQ075DL-E01C Specifications

Microstep Size (Default Resolution)	1.984375 μm
Built-in Controller	Yes
Travel Range	75 mm (2.953")
Accuracy (unidirectional)	108 μm (0.004252")
Repeatability	< 4 μm (< 0.000157")
Backlash	< 80 μm (< 0.003150")
Maximum Speed	840 mm/s (33.071"/s)
Minimum Speed	0.001212 mm/s (0.000048"/s)
Speed Resolution	0.001212 mm/s (0.000048"/s)
Encoder Resolution	500 CPR (2000 states/rev)
Encoder Type	Rotary quadrature encoder
Peak Thrust	35 N (7.8 lb)
Back-driving Force*	(\pm 30%) 27 N (6.1 lb)
Maximum Continuous Thrust	25 N (5.6 lb)
Communication Interface	RS-232
Communication Protocol	Zaber ASCII (Default), Zaber Binary
Data Cable Connection	Locking 4-pin M8
Maximum Centered Load	1000 N (224.3 lb)
Maximum Moment (Pitch)	30 N-m (22.1 ft-lb)
Maximum Moment (Roll)	30 N-m (22.1 ft-lb)
Maximum Moment (Yaw)	30 N-m (22.1 ft-lb)
Vertical Runout	< 20 μm (< 0.000787")
Horizontal Runout	< 20 μm (< 0.000787")
Pitch	0.025° (0.436 mrad)
Roll	0.01° (0.174 mrad)
Yaw	0.02° (0.349 mrad)
Stiffness in Pitch	250 N-m/° (70 $\mu\text{rad/N-m}$)
Stiffness in Roll	600 N-m/° (29 $\mu\text{rad/N-m}$)
Stiffness in Yaw	430 N-m/° (41 $\mu\text{rad/N-m}$)
Power Supply	24-48 VDC
Power Plug	2-pin screw terminal

Microstep Size (Default Resolution)	1.984375 μm
Maximum Current Draw	1900 mA
Linear Motion Per Motor Rev	25.4 mm (1.000")
Motor Steps Per Rev	200
Motor Type	Stepper (2 phase)
Motor Rated Current	2300 mA/phase
Inductance	2.8 mH/phase
Default Resolution	1/64 of a step
Guide Type	Recirculating Ball Linear Guide
Mechanical Drive System	Precision lead screw
Limit or Home Sensing	Magnetic home sensor
Manual Control	Indexed knob with push switch
Axes of Motion	1
LED Indicators	Yes
Mounting Interface	M6 and M3 threaded holes
Operating Temperature Range	0 to 50 °C
CE Compliant	Yes
Vacuum Compatible	No
Weight	2.38 kg (5.247 lb)

X-LRQ-EC Series Charts

Thrust Speed Performance



Thrust Speed Performance



Thrust Speed Performance



Thrust Speed Performance



Thrust Speed Performance



LRQ Linear Bearing Lifetime



Contact

Email: contact@zaber.com

Phone (toll free Canada/USA): 1-888-276-8033

Phone (direct): 1-604-569-3780

Fax: 1-604-648-8033

Zaber Technologies Inc.

#2 - 605 West Kent Ave. N.

Vancouver, British Columbia

Canada, V6P 6T7

<https://www.zaber.com>