

## X-LRQ450BL-SV2 Datasheet



- Vacuum compatible to 10<sup>-6</sup> Torr
- 75, 150, 300, 450, 600 mm travel
- Up to 205 mm/s speed and up to 100 N thrust
- 100 kg load capacity
- Built-in controller; daisy-chains with other Zaber products
- Only 4 feedthrough wires required to control all units in the daisy-chain via serial port (with an X-PIB adaptor)
- Custom versions available

### X-LRQ-SV2 Series Overview

For more information about the basics of a vacuum system and considerations to keep in mind when gathering requirements for your application, read our technical article, "Motion Device Design Considerations for Vacuum Applications".

Zaber's X-LRQ-SV2 Series devices are high-vacuum, computer-controlled, motorized linear stages with high stiffness, load, and lifetime capabilities in a compact size. They are stand-alone units requiring only a standard 24 V or 48 V power supply.

These stages connect to the RS-232 port or USB port of any computer, and they can be daisy-chained with any other Zaber products. The daisy-chain also shares power, making it possible for multiple X-Series products to share a single power supply.

At only 36 mm high, these vacuum stages are excellent for applications where a low profile is required. The X-LRQ-SV2's innovative design allows speeds up to 205 mm/s and loads up to 100 kg. Like all of Zaber's products, the X-LRQ-SV2 Series is designed to be 'plug and play' and very easy to set up and operate. These stages can bolt together into an XY system.

For more information visit: <https://www.zaber.com/products/vacuum-compatible-stages/X-LRQ-SV2>

## X-LRQ-SV2 Series Part Numbering & Options

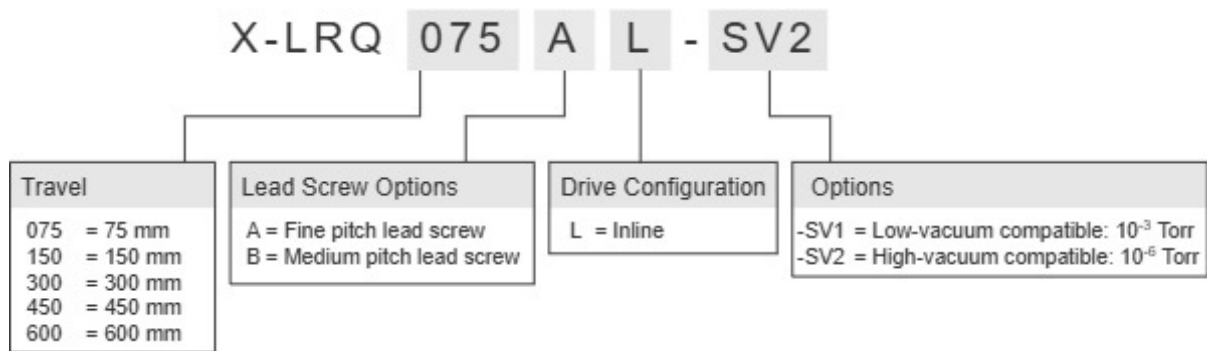

## X-LRQ450BL-SV2 Drawings

- [X-LRQxL-SV.png \(Dimension Drawing for the X-LRQxL-SV\)](#)

## X-LRQ450BL-SV2 Specifications

<b>Microstep Size (Default Resolution)</b>	<b>0.49609375 <math>\mu\text{m}</math></b>
Built-in Controller	Yes
Travel Range	450 mm (17.716")
Accuracy (unidirectional)	60 $\mu\text{m}$ (0.002362")
Repeatability	< 2.5 $\mu\text{m}$ (< 0.000098")
Backlash	< 21 $\mu\text{m}$ (< 0.000827")
Maximum Speed	205 mm/s (8.071"/s)
Minimum Speed	0.000303 mm/s (0.000012"/s)
Speed Resolution	0.000303 mm/s (0.000012"/s)
Peak Thrust	60 N (13.5 lb)
Maximum Continuous Thrust	60 N (13.5 lb)
Communication Interface	RS-232
Communication Protocol	Zaber ASCII (Default), Zaber Binary
Data Cable Connection	Teflon flying leads with M8 4 pin M/F
Maximum Centered Load	1000 N (224.3 lb)
Maximum Moment (Pitch)	30 N-m (22.1 ft-lb)
Maximum Moment (Roll)	30 N-m (22.1 ft-lb)
Maximum Moment (Yaw)	30 N-m (22.1 ft-lb)
Vertical Runout	< 45 $\mu\text{m}$ (< 0.001772")
Horizontal Runout	< 40 $\mu\text{m}$ (< 0.001575")
Pitch	0.04° (0.698 mrad)
Roll	0.025° (0.436 mrad)
Yaw	0.04° (0.698 mrad)
Stiffness in Pitch	500 N-m/° (35 $\mu\text{rad/N-m}$ )
Stiffness in Roll	1180 N-m/° (15 $\mu\text{rad/N-m}$ )
Stiffness in Yaw	450 N-m/° (39 $\mu\text{rad/N-m}$ )
Power Supply	24-48 VDC
Power Plug	None, use X-PIB
Maximum Current Draw	1900 mA
Linear Motion Per Motor Rev	6.35 mm (0.250")
Motor Steps Per Rev	200

<b>Microstep Size (Default Resolution)</b>	<b>0.49609375 <math>\mu\text{m}</math></b>
Motor Type	Stepper (2 phase)
Motor Rated Current	2100 mA/phase
Inductance	2.8 mH/phase
Default Resolution	1/64 of a step
Guide Type	Recirculating Ball Linear Guide
Mechanical Drive System	Precision lead screw
Limit or Home Sensing	Magnetic home sensor
Manual Control	No
Axes of Motion	1
LED Indicators	Yes
Mounting Interface	M6 and M3 threaded holes
Operating Temperature Range	0 to 50 °C
CE Compliant	Yes
Vacuum Compatible	High vacuum (10 <sup>-6</sup> Torr)
Weight	4.15 kg (9.149 lb)

# X-LRQ-SV2 Series Charts

## Thrust Speed Performance

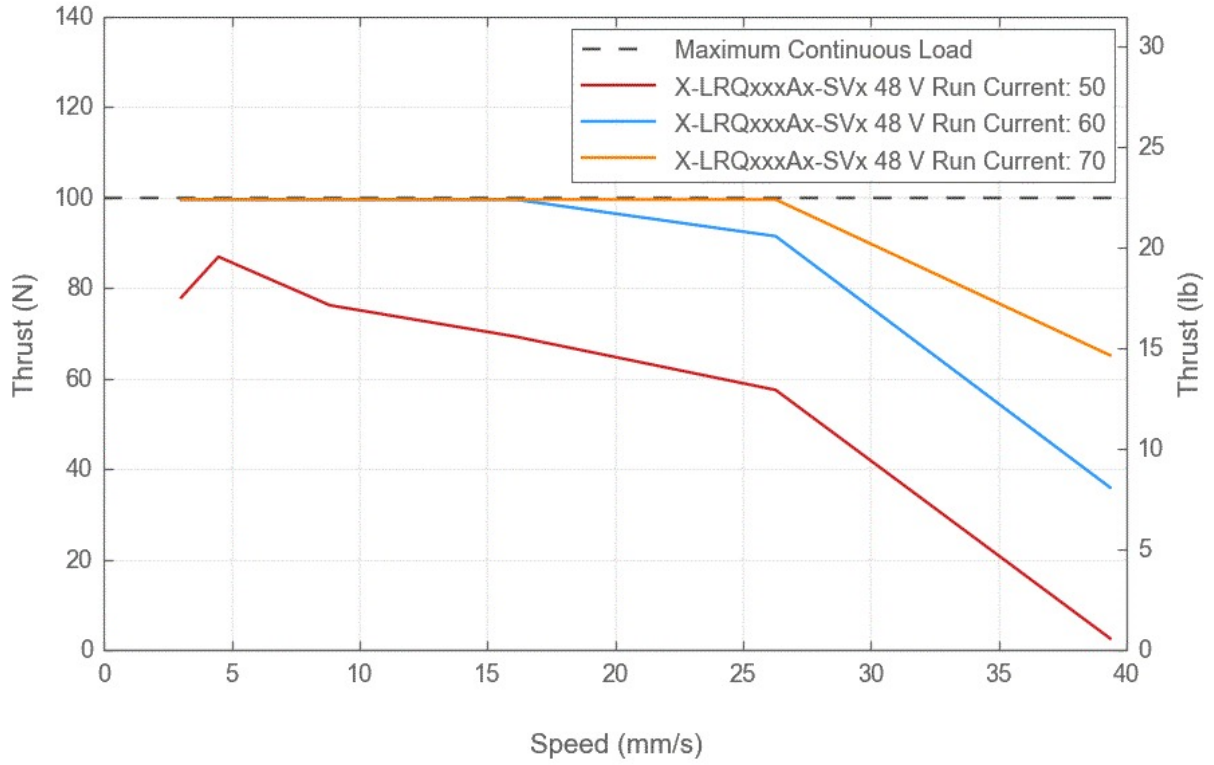

### Thrust Speed Performance

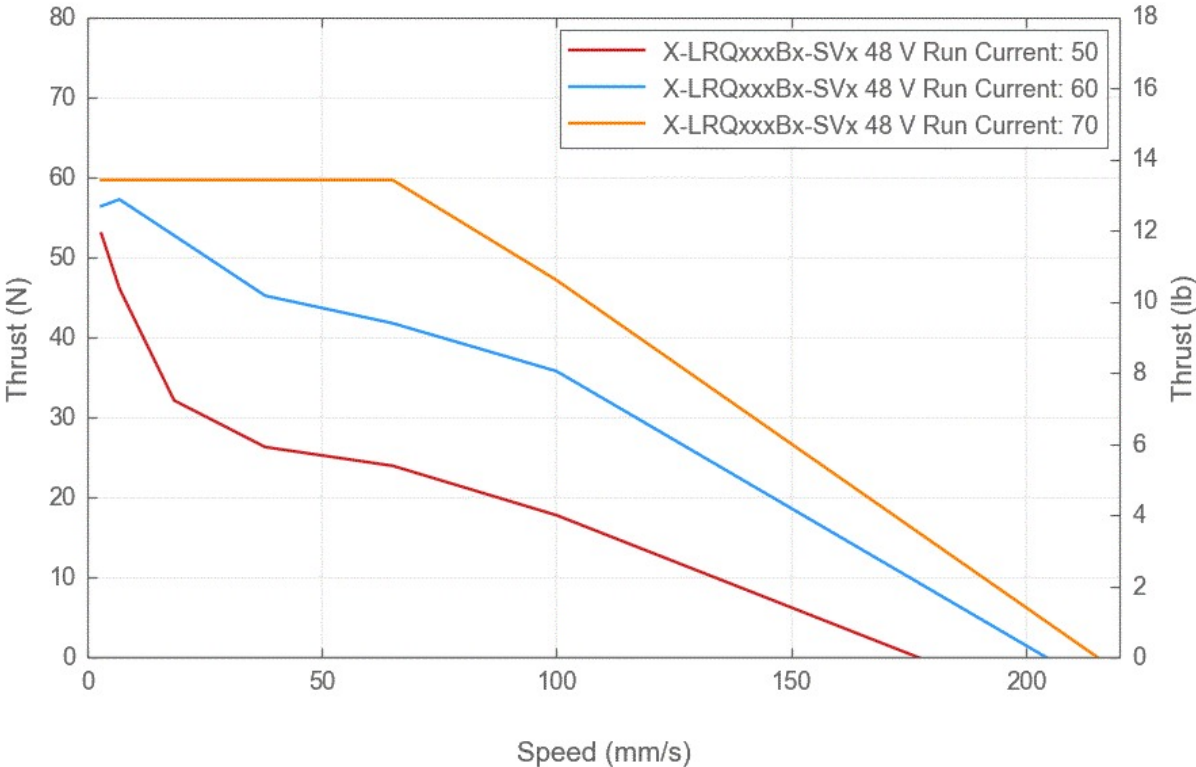

### Recommended Duty Cycle

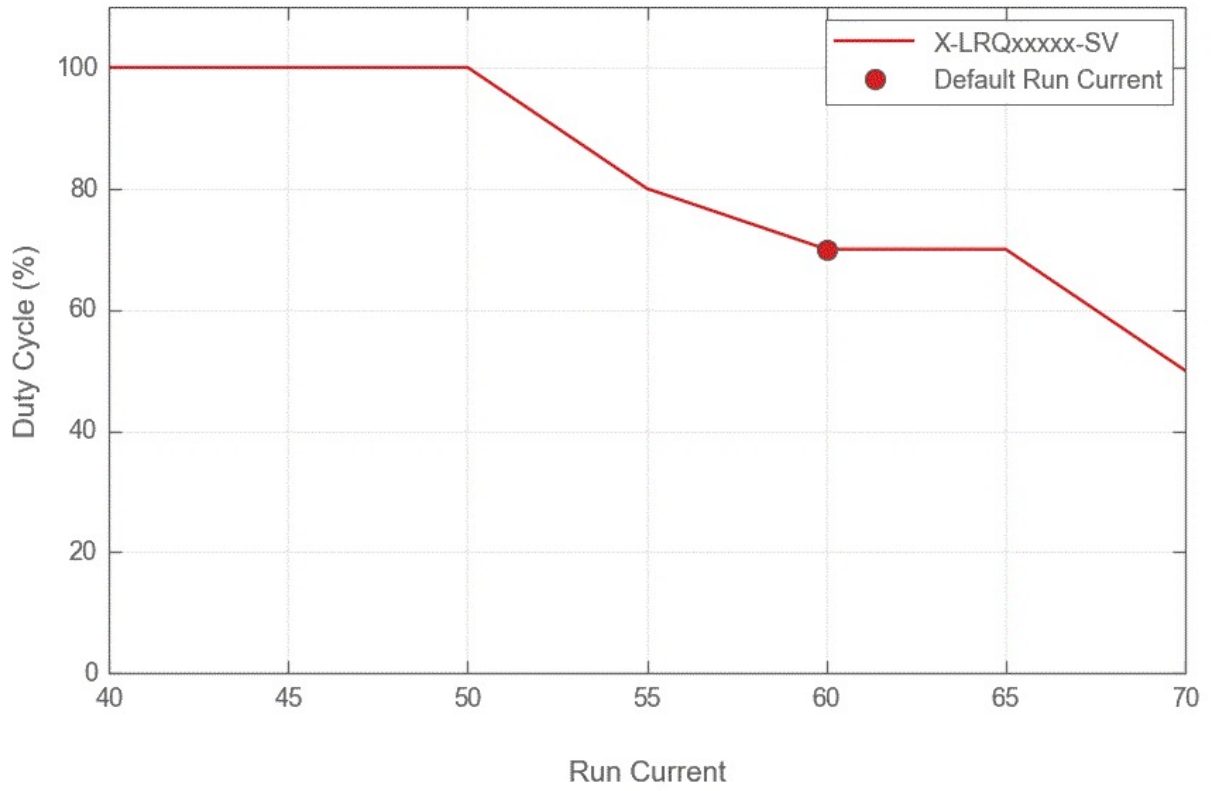

### LRQ Linear Bearing Lifetime



## Contact

Email: [contact@zaber.com](mailto:contact@zaber.com)

Phone (toll free Canada/USA): 1-888-276-8033

Phone (direct): 1-604-569-3780

Fax: 1-604-648-8033

Zaber Technologies Inc.

#2 - 605 West Kent Ave. N.

Vancouver, British Columbia

Canada, V6P 6T7

<https://www.zaber.com>