

X-LRT0100BL-BAE53C Datasheet



- 100, 250, 500, 750, 1000, 1500 mm travel
- 20 μm full travel accuracy
- 300 kg load capacity
- Includes stainless steel dust covers
- Ball screw and lead screw configurations
- Optional integrated power-off brake for vertical applications
- Integrated linear encoders with 50 nm resolution provide slip/stall detection and position correction
- Built-in controller; daisy-chains with other Zaber products

X-LRT-AEC Series Overview

Zaber's X-LRT-AEC Series are computer-controlled, motorized linear stages designed for positioning high loads to within 20 μm accuracy. An integrated linear encoder combined with stage calibration provides high accuracy positioning over the full travel of the device. They have low pitch, roll, yaw and runout and long lifetime. Flexible dust covers keep out moderate debris. An indexed knob provides convenient manual control for versatile operation even without a computer. An optional power-off brake is available to enable vertical applications with backdrivable screws.

X-LRT-AEC devices are stand-alone units requiring only a standard 48 V power supply. They connect to the RS-232 port or USB port of any computer, and can be daisy-chained with any other Zaber products. Like all of Zaber's products, the X-LRT-AEC Series is designed to be 'plug and play' and very easy to set up and operate.

For more information visit: <https://www.zaber.com/products/linear-stages/X-LRT-AEC>

X-LRT-AEC Series Part Numbering & Options

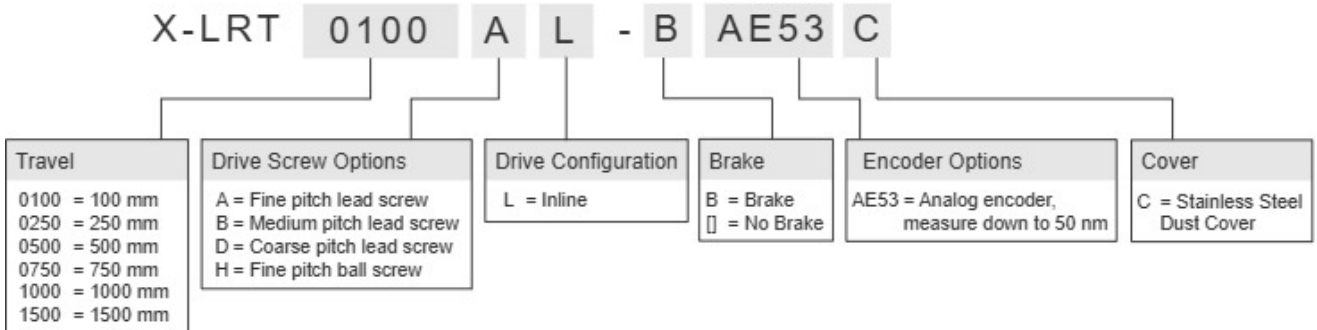

X-LRT0100BL-BAE53C Drawings

- [X-LRT-BAEC.png \(Drawing for the X-LRT-BAEC\)](#)

X-LRT0100BL-BAE53C Specifications

Microstep Size (Default Resolution)	0.49609375 μm
Built-in Controller	Yes
Travel Range	100 mm (3.937")
Accuracy (unidirectional)	20 μm (0.000787")
Repeatability	< 1.5 μm (< 0.000059")
Minimum Incremental Move	2000 nm
Backlash	< 15 μm (< 0.000591")
Maximum Speed	175 mm/s (6.890"/s)
Minimum Speed	0.000303 mm/s (0.000012"/s)
Speed Resolution	0.000303 mm/s (0.000012"/s)
Encoder Type	Linear analog encoder
Encoder Resolution	50 nm
Peak Thrust	600 N (134.6 lb)
Back-driving Force*	(\pm 30%) 420 N (94.2 lb)
Maximum Continuous Thrust	600 N (134.6 lb)
Communication Interface	RS-232
Communication Protocol	Zaber ASCII (Default)
Data Cable Connection	Locking 4-pin M8
Maximum Centered Load	2940 N (659.3 lb)
Maximum Moment (Pitch)	70 N-m (51.7 ft-lb)
Maximum Moment (Roll)	80 N-m (59.0 ft-lb)
Maximum Moment (Yaw)	70 N-m (51.7 ft-lb)
Vertical Runout	< 10 μm (< 0.000394")
Horizontal Runout	< 50 μm (< 0.001968")
Pitch	0.015° (0.262 mrad)
Roll	0.02° (0.349 mrad)
Yaw	0.03° (0.523 mrad)
Stiffness in Pitch	1400 N-m/° (12 $\mu\text{rad/N-m}$)
Stiffness in Roll	700 N-m/° (25 $\mu\text{rad/N-m}$)
Stiffness in Yaw	1200 N-m/° (15 $\mu\text{rad/N-m}$)
Power Supply	24-48 VDC

Microstep Size (Default Resolution)	0.49609375 μm
Power Plug	2-pin screw terminal
Maximum Current Draw	3600 mA
Linear Motion Per Motor Rev	6.35 mm (0.250")
Motor Steps Per Rev	200
Motor Type	Stepper (2 phase)
Motor Rated Current	3000 mA/phase
Inductance	2 mH/phase
Default Resolution	1/64 of a step
Guide Type	Recirculating Ball Linear Guide
Mechanical Drive System	Precision lead screw
Limit or Home Sensing	Linear Encoder Index Mark
Manual Control	Indexed knob with push switch
Axes of Motion	1
LED Indicators	Yes
Maximum Axial Brake Force	600 N (134.9 lb)
Operating Temperature Range	0 to 50 °C
CE Compliant	Yes
Vacuum Compatible	No
Weight	4.276 kg (9.427 lb)

X-LRT-AEC Series Charts

Typical Microstepping Accuracy



Typical Microstepping Accuracy



Typical Microstepping Accuracy



Typical Microstepping Accuracy



Thrust Speed Performance



Thrust Speed Performance



Thrust Speed Performance



Thrust Speed Performance



Thrust Speed Performance



Typical Minimum Incremental Move



Typical Minimum Incremental Move



Typical Minimum Incremental Move



Typical Minimum Incremental Move



Typical LRT Bearing Lifetime



Contact

Email: contact@zaber.com

Phone (toll free Canada/USA): 1-888-276-8033

Phone (direct): 1-604-569-3780

Fax: 1-604-648-8033

Zaber Technologies Inc.

#2 - 605 West Kent Ave. N.

Vancouver, British Columbia

Canada, V6P 6T7

<https://www.zaber.com>