

ZABER

X-ADR250B100B-SAE53D12

Direct Drive XY Microscope Stage
dimensions in mm

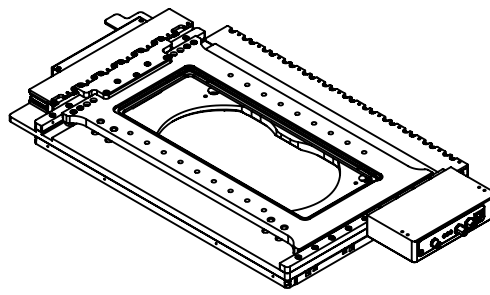

Adaptor plates required for most applications.
See accessories page for details at www.zaber.com

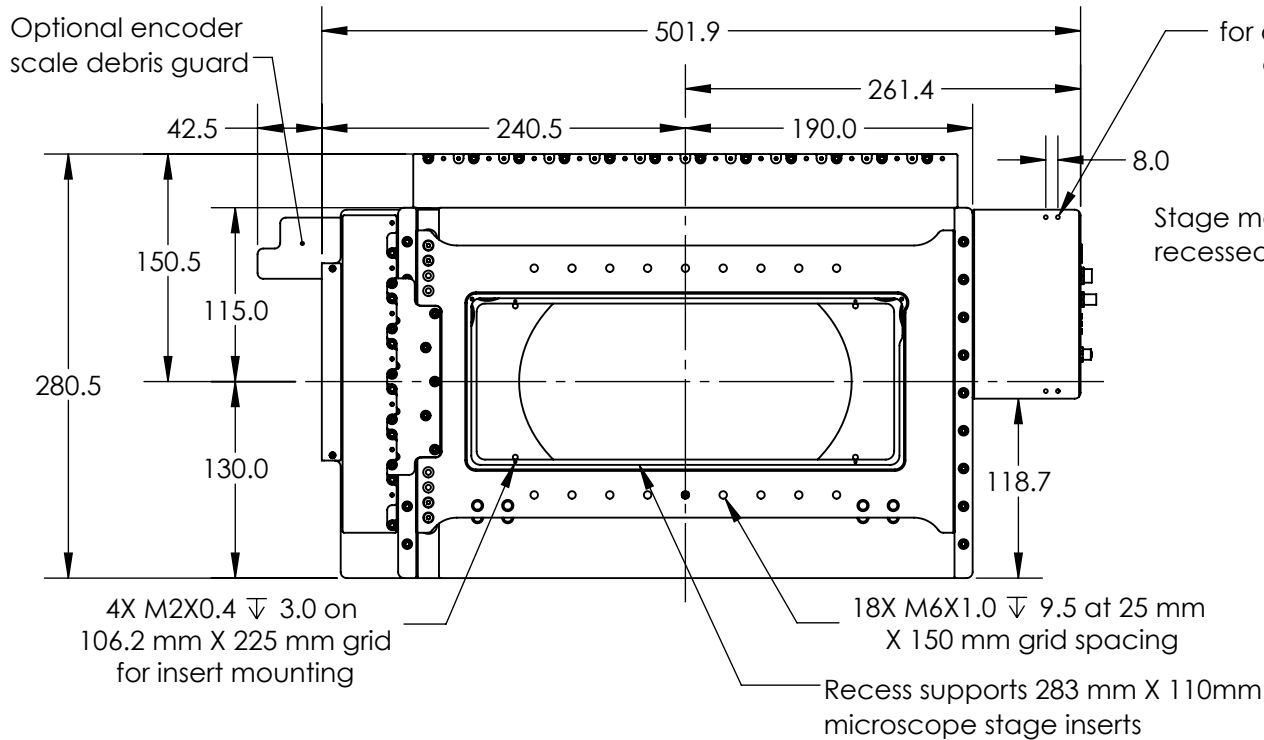

4X M3X0.5 ∇ 6.0
for optional CG01T or CG02T
cable guide mounting

Base-plate mounting features

Stage mounting surface
recessed on underside

4X Mounting holes for M6
or [1/4"-20] screws.

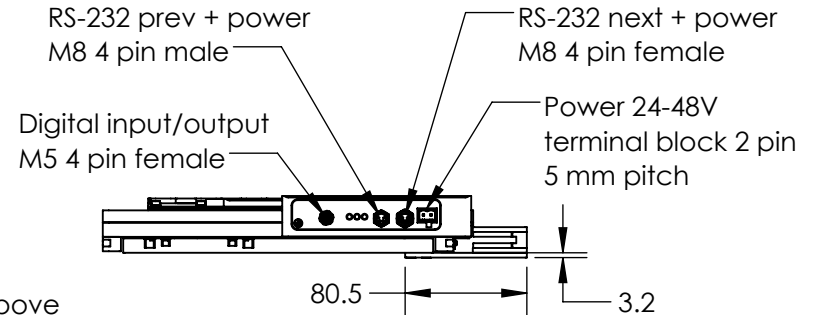
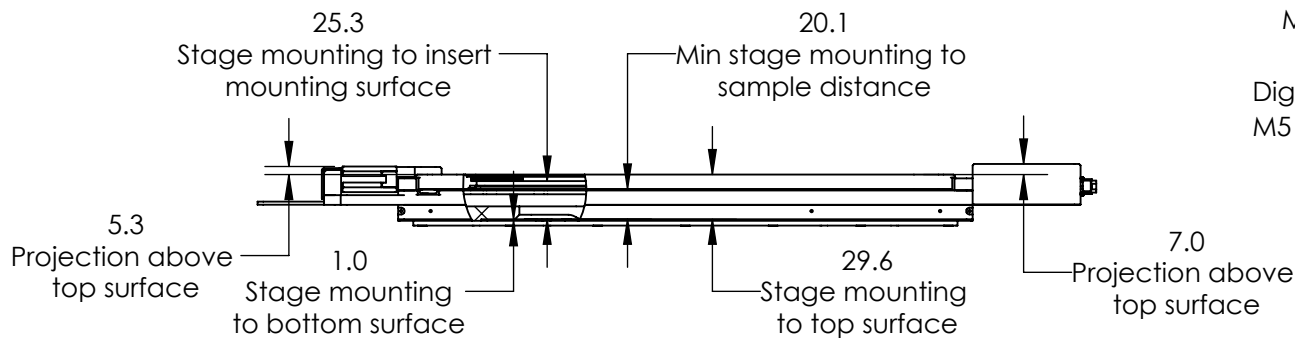
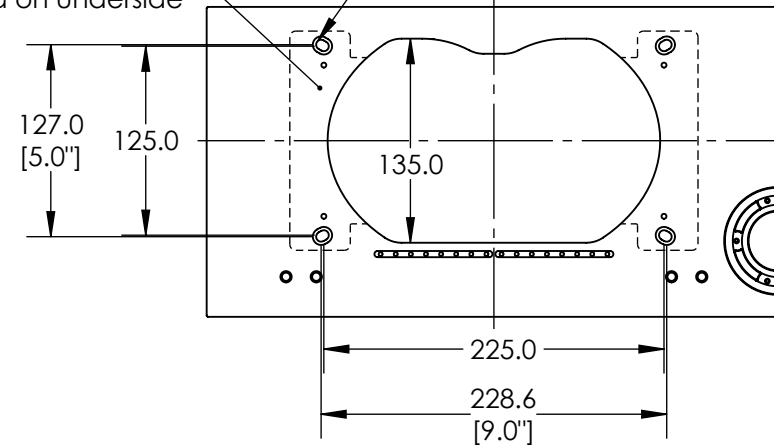

ZABER

X-ADR250B100B-SAE53D12
 Direct Drive XY Microscope Stage
 dimensions in mm

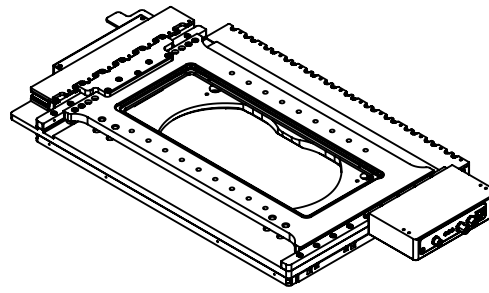

Axis	Nominal Travel	Max Hard Stop Travel	Min Hard Stop Travel
Upper	100.0	105.0	55.0
Lower	250.0	260.0	140.0

Hard stop travel limits can be reduced in 5 mm increments (upper axis) and 10 mm increments (lower axis) for space constrained applications.

